

2. Specification

2-1. GSM General Specification

	GSM850	EGSM 900	DCS1800	PCS1900	WCDMA 2100	WCDMA 1900	WCDMA 900	WCDMA 850
Freq. Band [MHz] Uplink/ Downlink	824~849 869~894	880~915 925~960	1710~1785 1805~1880	1850~1910 1930~1990	1922~1977 2112~2167	1852~1907 1932~1987	880~915 925~960	824~849 869~894
ARFCN range	128~251	0~124 & 975~1023	512~885	512~810	UL: 9612~9888 DL: 10562~10838	UL: 9262~9538 DL: 9662~9938	UL: 2712~2863 DL: 2937~3088	UL: 4132~4233 DL: 4357~4458
Tx/Rx spacing	45MHz	45MHz	95MHz	80MHz	190MHz	80MHz	45MHz	45MHz
Mod. Bit rate/ Bit Period	270.833kbps 3.692us	270.833kbps 3.692us	270.833kbps 3.692us	270.833kbps 3.692us	3.84Mcps	3.84Mcps	3.84Mcps	3.84Mcps
Time Slot Period/ Frame Period	576.9us 4.615ms	576.9us 4.615ms	576.9us 4.615ms	576.9us 4.615ms	FrameLength: 10ms Slotlength: 0.667ms	FrameLength: 10ms Slotlength: 0.667ms	FrameLength: 10ms Slotlength: 0.667ms	FrameLength: 10ms Slotlength: 0.667ms
Modulation	0.3GMSK	0.3GMSK	0.3GMSK	0.3GMSK	QPSKHQPSK	QPSKHQPSK	QPSKHQPSK	QPSKHQPSK
MS Power	33dBm~5dBm	33dBm~5dBm	30dBm~0dBm	30dBm~0dBm	24dBm~ -50dBm	24dBm~ -50dBm	24dBm~ -50dBm	24dBm~ -50dBm
Power Class	5pcl ~ 19pcl	5pcl ~ 19pcl	0pcl ~ 15pcl	0pcl ~ 15pcl	3(max+24dBm)	3(max+24dBm)	3(max+24dBm)	3(max+24dBm)
Sensitivity	-102dBm	-102dBm	-100dBm	-100dBm	-106.7dBm	-106.7dBm	-106.7dBm	-106.7dBm
TDMA Mux	8	8	8	8	8	8	8	8
Cell Radius	35Km	35Km	2Km	2Km	2Km	2Km	2Km	2Km

2-2. GSM Tx Power Class

TX Power control level	GSM850	TX Power control level	EGSM900	TX Power control level	DCS1800	TX Power control level	PCS1900
5	33±2 dBm	5	33±2 dBm	0	30±3 dBm	0	30±3 dBm
6	31±2 dBm	6	31±2 dBm	1	28±3 dBm	1	28±3 dBm
7	29±2 dBm	7	29±2 dBm	2	26±3 dBm	2	26±3 dBm
8	27±2 dBm	8	27±2 dBm	3	24±3 dBm	3	24±3 dBm
9	25±2 dBm	9	25±2 dBm	4	22±3 dBm	4	22±3 dBm
10	23±2 dBm	10	23±2 dBm	5	20±3 dBm	5	20±3 dBm
11	21±2 dBm	11	21±2 dBm	6	18±3 dBm	6	18±3 dBm
12	19±2 dBm	12	19±2 dBm	7	16±3 dBm	7	16±3 dBm
13	17±2 dBm	13	17±2 dBm	8	14±3 dBm	8	14±3 dBm
14	15±2 dBm	14	15±2 dBm	9	12±4 dBm	9	12±4 dBm
15	13±2 dBm	15	13±2 dBm	10	10±4 dBm	10	10±4 dBm
16	11±3 dBm	16	11±3 dBm	11	8±4 dBm	11	8±4 dBm
17	9±3dBm	17	9±3dBm	12	6±4 dBm	12	6±4 dBm
18	7±3 dBm	18	7±3 dBm	13	4±4 dBm	13	4±4 dBm
19	5±3 dBm	19	5±3 dBm	14	2±5 dBm	14	2±5 dBm
				15	0±5 dBm	15	0±5 dBm

2-3. LTE General Specification

	LTE Band1	LTE Band3	LTE Band5	LTE Band7	LTE Band8	LTE Band 20	LTE Band 40
Freq. Band[MHz] Uplink/ Downlink	1920~1980 2110~2170	1710~1785 1805~1880	824~849 869~894	2500~2570 1805~1880	2500~2570 1805~1880	704~716 734~746	2300~2400
ARFCN range	UL: 18000~18599 DL: 0~599	UL: 19200~19950 DL: 1805~1880	UL: 20400~20649 DL: 2400~2649	UL: 20750~21449 DL: 2750~3449	UL: 21450~21799 DL: 3450~3799	UL: 24150~24449 DL: 6150~6449	UL, DL : 2300~2400
Tx/Rx spacing	190MHz	95MHz	45MHz	120MHz	45MHz	41MHz	-
Channel Bandwidth	60 MHz	75 MHz	25 MHz	70 MHz	35 MHz	30 MHz	5/10/15/20 MHz
Modulation	QPSK,16/64QAM	QPSK,16/64QAM	QPSK,16/64QAM	QPSK,16/64QAM	QPSK,16/64QAM	QPSK,16/64QAM	QPSK,16/64QAM
MS Power (MPR)	-35~25.7 dBm	-35~25.7 dBm	-35~25.7 dBm	-35~25.7 dBm	-35~25.7 dBm	-35~25.7 dBm	-35~25.7 dBm
Sensitivity (QPSK) (BW 10MHz)	-94 dBm	-92 dBm	-92 dBm	-95dBm	-95dBm	-95dBm	-95dBm
Cell Radius	>5Km	>5Km	>5Km	>5Km	>5Km	>5Km	>5Km

3. Operation Instruction and Installation

Main Function

Item	Description
OS	Android V5.1 (Lollipop)
RF	LTE Cat.4 (150/50Mbps)
Battery	3,000mAh
Base Band	1.2GHz Quad
Other RF	A-GPS, Glonass, Beidou, BT4.1, USB 2.0, WIFI 802.11 b/g/n SISO
Camera	13MP Main CAM 5MP(Front)
LCD	5.5" HD LCD TFT, 720 x 1280
RAM	1.5GB RAM + 8GB eMMC
Sensor	Accelerometer, Proximity
Accessory	Charger: 5V/1A Data cable: 2.7pi, 1.2m Ear phone: 3.5pi, 4pin

9. Reference Abbreviate

Reference Abbreviate

- **AAC**: Advanced Audio Coding.
- **AVC** : Advanced Video Coding.
- **BER** : Bit Error Rate
- **BPSK**: Binary Phase Shift Keying
- **CA** : Conditional Access
- **CDM** : Code Division Multiplexing
- **C/I** : Carrier to Interference
- **DMB** : Digital Multimedia Broadcasting
- **EN** : European Standard
- **ES** : Elementary Stream
- **ETSI**: European Telecommunications Standards Institute
- **MPEG**: Moving Picture Experts Group
- **PN** : Pseudo-random Noise
- **PS** : Pilot Symbol
- **QPSK**: Quadrature Phase Shift Keying
- **RS** : Reed-Solomon
- **SI** : Service Information
- **TDM** : Time Division Multiplexing
- **TS** : Transport Stream

1. Safety Precautions

1-1. Repair Precaution

Before attempting any repair or detailed tuning, shield the device from RF noise or static electricity discharges.

Use only demagnetized tools that are specifically designed for small electronic repairs, as most electronic parts are sensitive to electromagnetic forces.

Use only high quality screwdrivers when servicing products. Low quality screwdrivers can easily damage the heads of screws.

Use only conductor wire of the properly gauge and insulation for low resistance, because of the low margin of error of most testing equipment.

We recommend 22-gauge twisted copper wire.

Hand-soldering is not recommended, because printed circuit boards (PCBs) can be easily damaged, even with relatively low heat. Never use a soldering iron with a power rating of more than 100 watts and use only lead-free solder with a melting point below 250°C (482°F).

Prior to disassembling the battery charger for repair, ensure that the AC power is disconnected. Always use the replacement parts that are registered in the SEC system. Third-party replacement parts may not function properly.

1-2. ESD(Electrostatically Sensitive Devices) Precaution

Many semiconductors and ESDs in electronic devices are particularly sensitive to static discharge and can be easily damaged by it. We recommend protecting these components with conductive anti-static bags when you store or transport them.

Always use an anti-static strap or wristband and remove electrostatic buildup or dissipate static electricity from your body before repairing ESDs.

Ensure that soldering irons have AC adapter with ground wires and that the ground wires are properly connected.

Use only desoldering tools with plastic tips to prevent static discharge.

Properly shield the work environment from accidental electrostatic discharge before opening packages containing ESDs.

The potential for static electricity discharge may be increased in low humidity environments, such as air-conditioned rooms. Increase the airflow to the working area to decrease the chance of accidental static electricity discharges.

6. Level 1 Repair

6-1. S/W installation

6-1-1. Required items in order to install S/W

- Installation program: Downloader Program (**Odin3 v3.10.6.exe**)
- Mobile Phone
- Data Cable
- Mobile device specific S/W: Binary files

✳ Settings

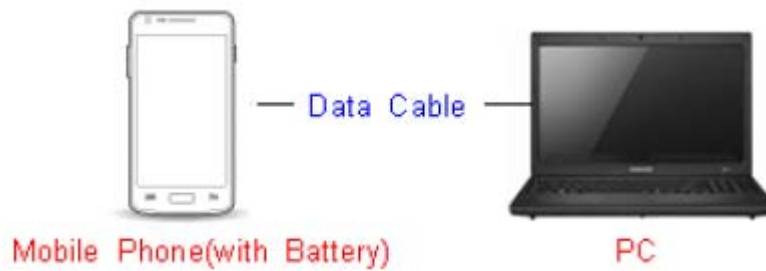

Data Cable : GH39-01710C

6-1-2. S/W Installation Program (Downloader program)

- Open up the S/W Installation Program by executing the "Odin3 v3.10.6.exe"

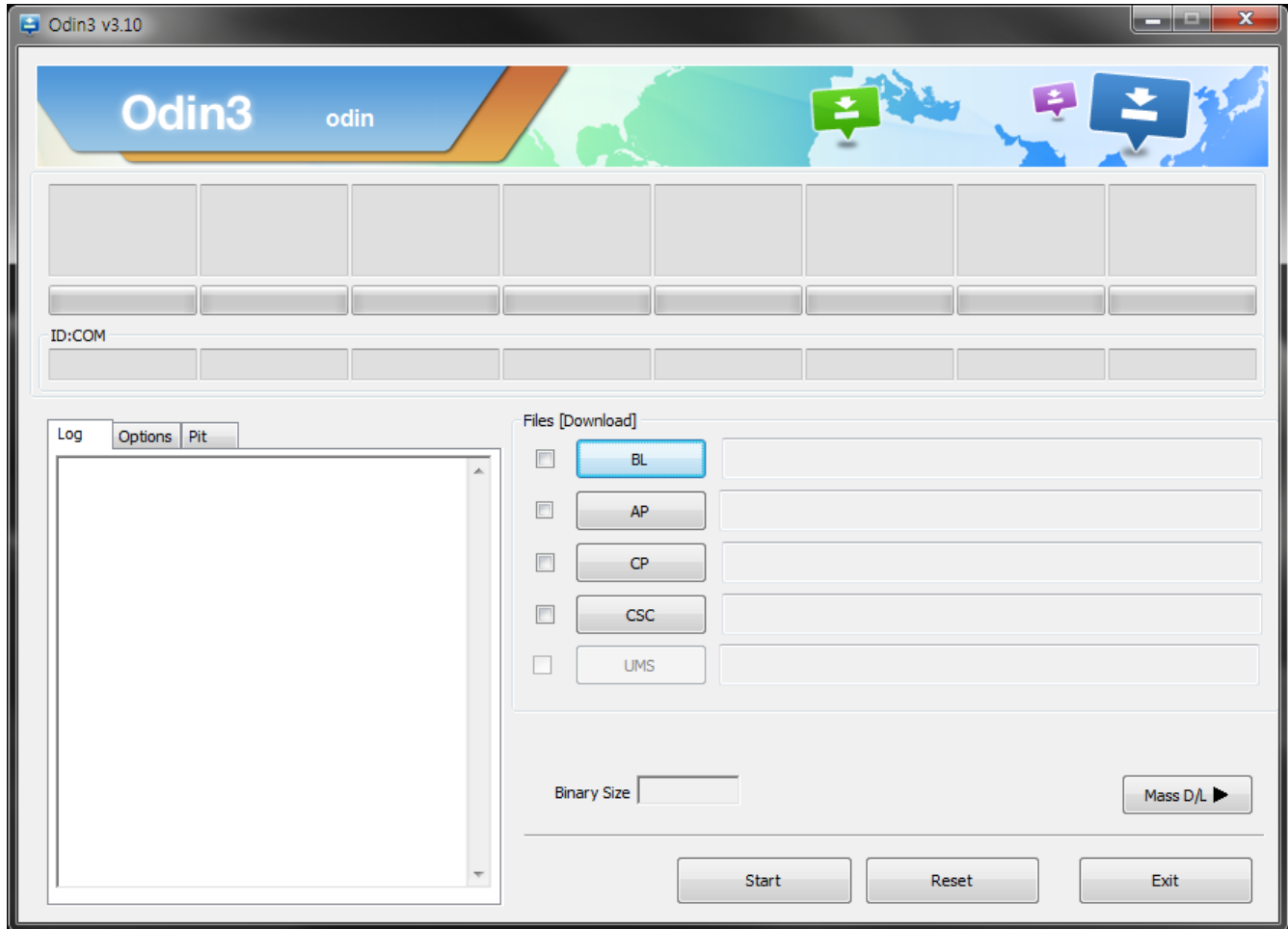

1. Enable the check mark by click on the following options,

- Check Auto Reboot, Re-Partition, and F. Reset Time
- Check PIT
- Check BOOTLOADER, PDA, PHONE, and CSC Files

* Note : "Odin v3.10 or above" checks MD5 checksum just after file selection.

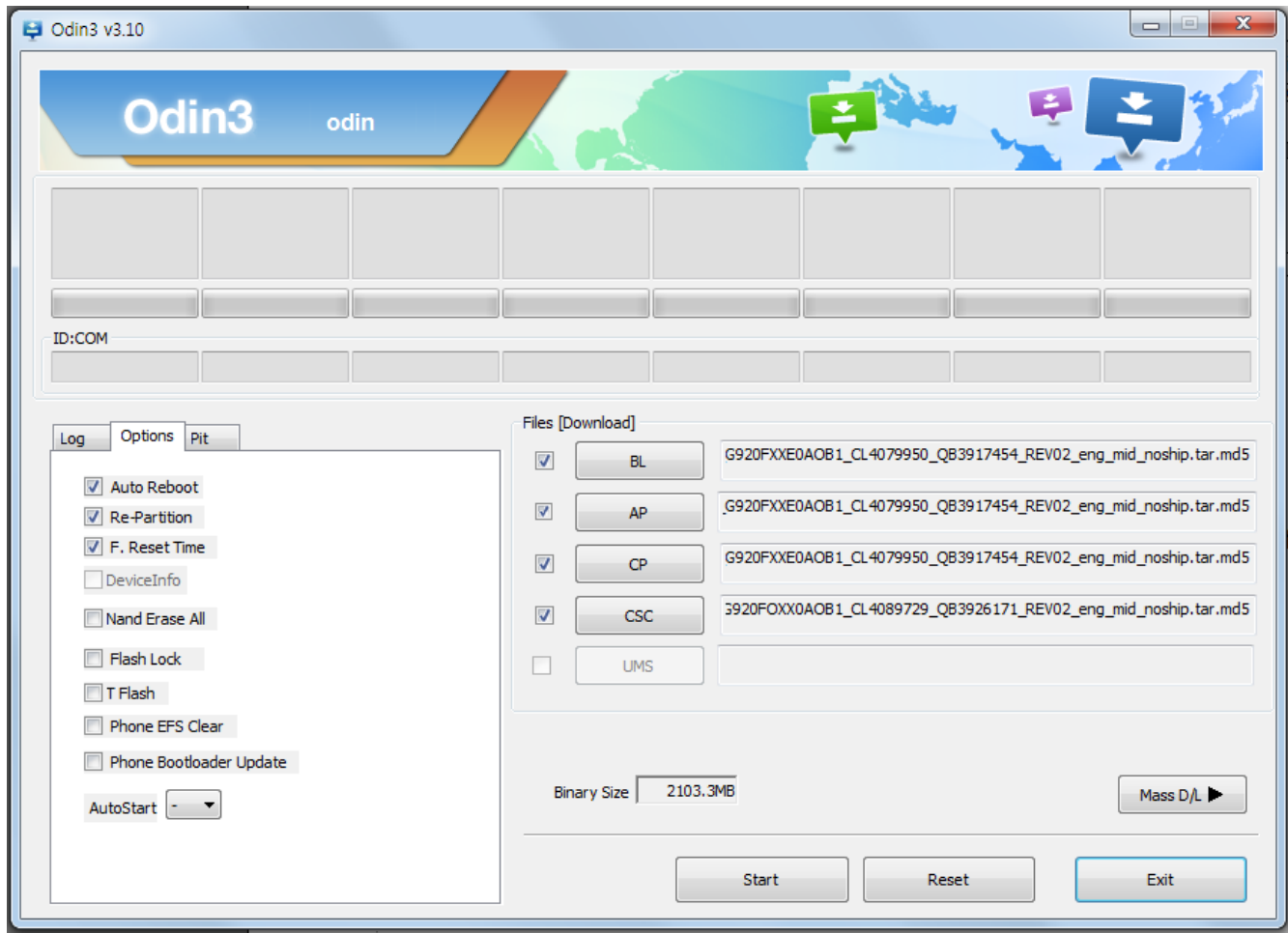

2. Enter into Download Mode

- Enter into Download Mode by pressing Volume Down button, Home button and ON/OFF Button simultaneously followed by pressing Volume up button as a direction of the phone.



3. Connect the device to PC via Data Cable.

Make sure that the one of communication ports [ID:COM] box is highlighted in sky blue. The device is now connected with the PC and ready to download the binary files in it.

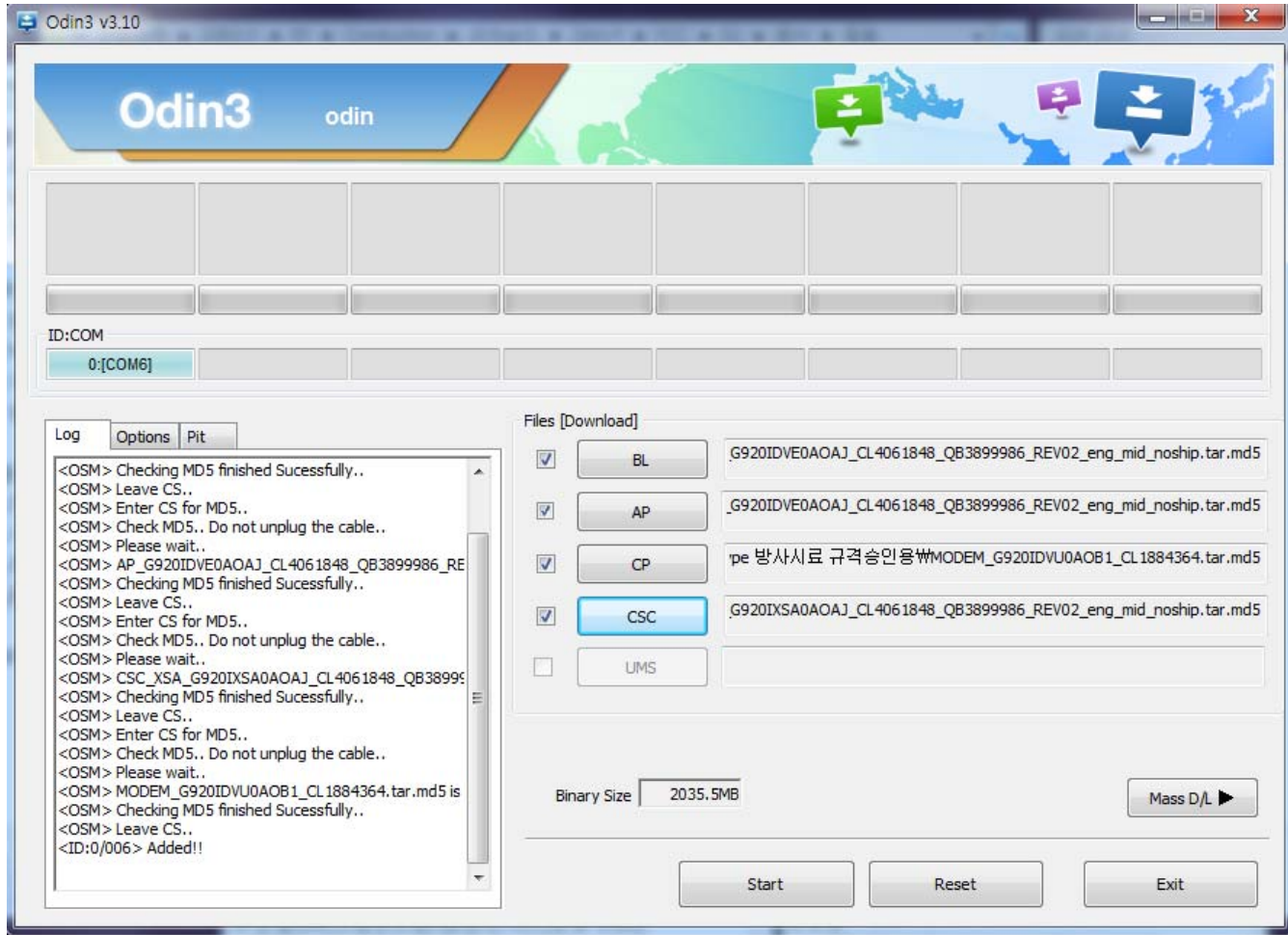

- Start downloading the binary files into the device by clicking Start button on the screen. The green colored "PASS!" sign will appear on the upper-left box if the binary files have been successfully downloaded into the device.

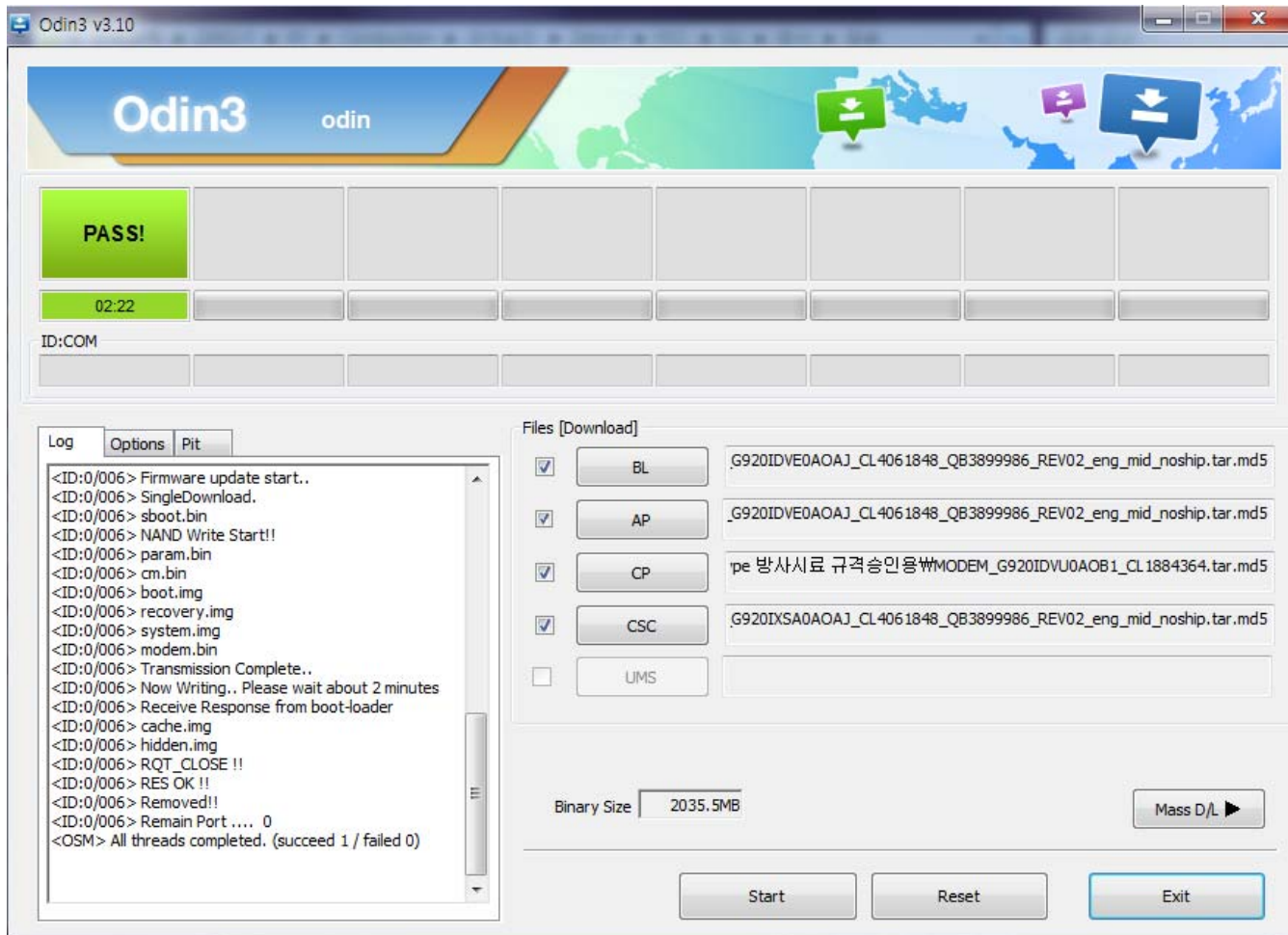

- Disconnect the device from the Data cable.
- Once the device boots up, you can check the version of the binary file or name by pressing the following code in sequence;
 - *#1234#**

You can perform Factory Reset by Settings → Accounts → Backup and reset

6-2 IMEI writing

6-2-1 Preparation

- New IMEI writing Program has been released.
- Supported Model : Models which CAB files are uploaded on HHPsvc INI File category, instead of ini file.
- Refer to below IMEI writing procedure.

- H/W

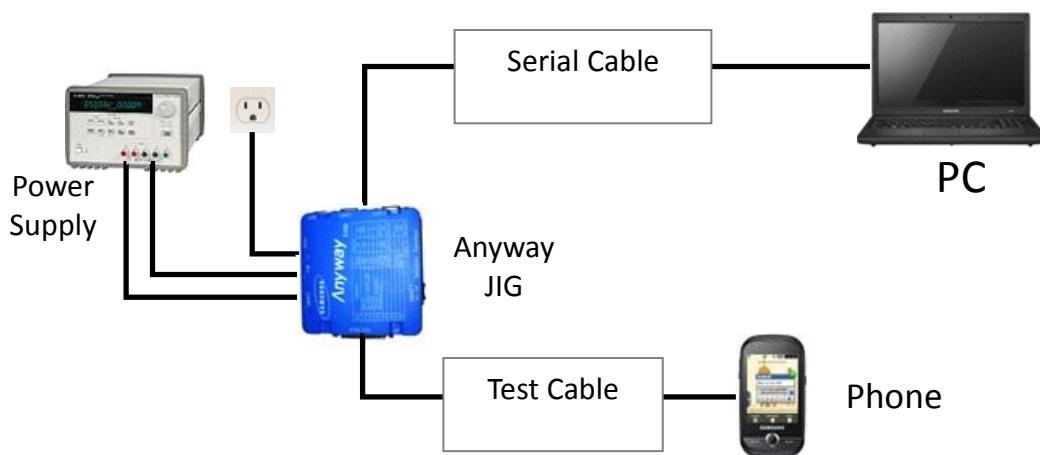

- S/W

① Library Install	To use Daseul, library files should be installed. Refer to SVC Bulletin “(11-82) Daseul (New IMEI writing Program) Library Install guide_rev1.0”
② Launcher	DASEUL_SVC_Launcher_v3_0_25 or higher -Uploaded on HHPsvc Notice
③ Runtime File	1. DASEUL_Runtime_Ver_3.1.139.0.CAB or higher -Uploaded on HHPsvc Notice 2. Make 'ModelName' folder at the same position with launcher & Runtime file.
④ Model File	Copy Model File under the 'Model Name' folder

6-2-2 IMEI writing Process

1. Run DASEUL_SVC_Launcher_v3.0.10.exe

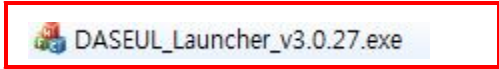

2. Select IMEI and then Extract & Run

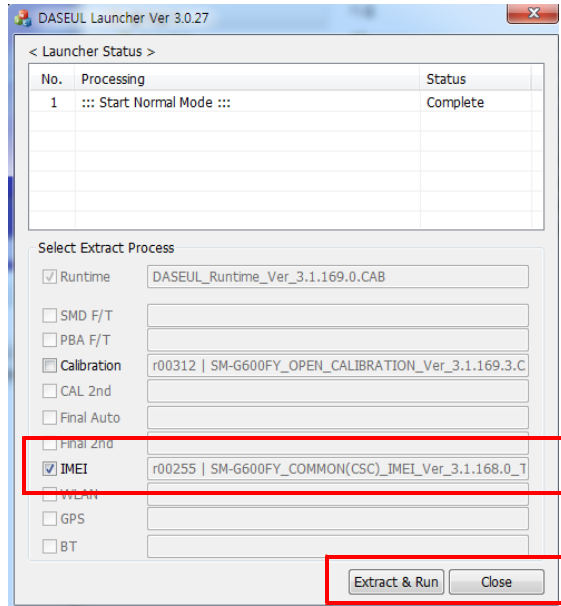

3. Check 'IMEI Write / IMEI Check', and click 'IMEI SVC & Repair Option'

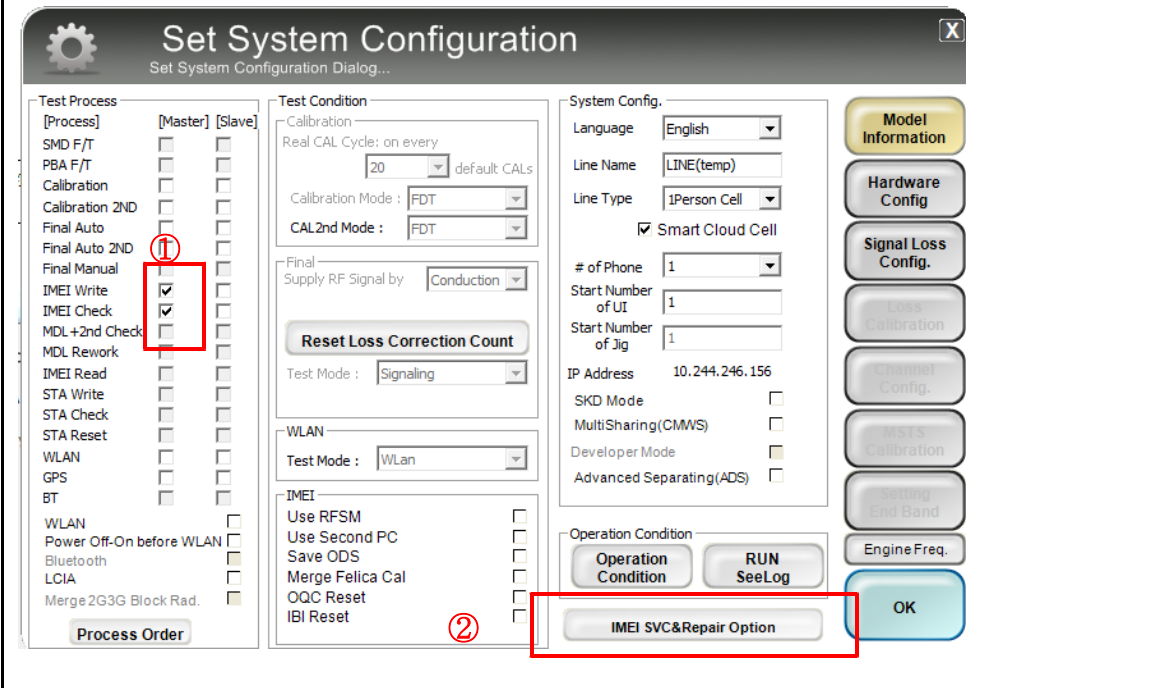

4. Check 'SVC , User Ticket No' and click OK

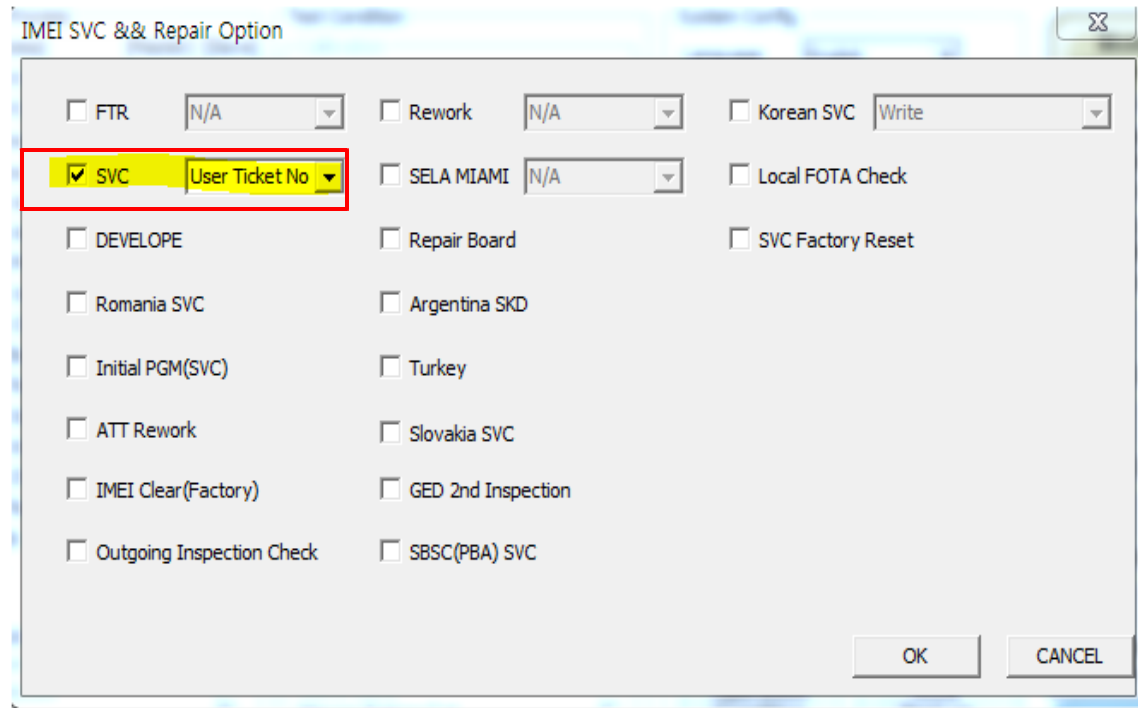

5. Click 'Hardware Config'

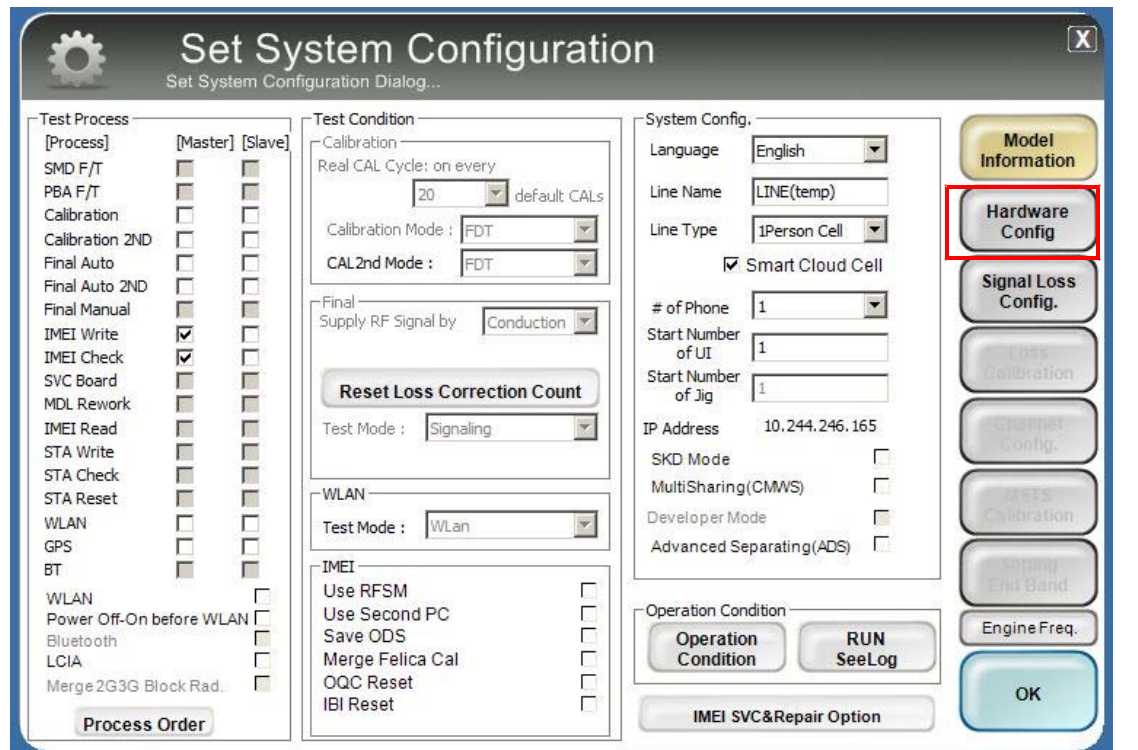

6. Click 'Port Setting'

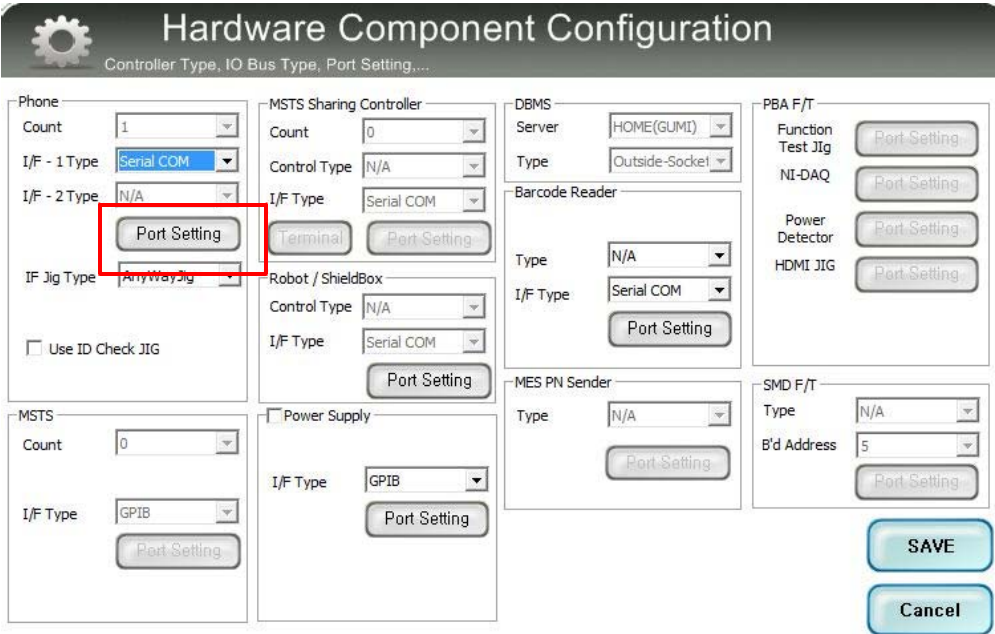

Hardware Component Configuration
Controller Type, IO Bus Type, Port Setting,...

Phone
Count: 1
I/F - 1 Type: Serial COM
I/F - 2 Type: N/A
I/F Jig Type: AnyWayJig
 Use ID Check JIG

MSTS Sharing Controller
Count: 0
Control Type: N/A
I/F Type: Serial COM
Terminal
Port Setting

DBMS
Server: HOME(GUMI)
Type: Outside-Socket

Barcode Reader
Type: N/A
I/F Type: Serial COM
Port Setting

MES PN Sender
Type: N/A
Port Setting

PBA F/T
Function Test Jig: Port Setting
NI-DAQ: Port Setting
Power Detector: Port Setting
HDMI JIG: Port Setting

MSTS
Count: 0
I/F Type: GPIB
Port Setting

Power Supply
I/F Type: GPIB
Port Setting

SMD F/T
Type: N/A
B'd Address: 5
Port Setting

SAVE
Cancel

7. Select Port Number and SAVE

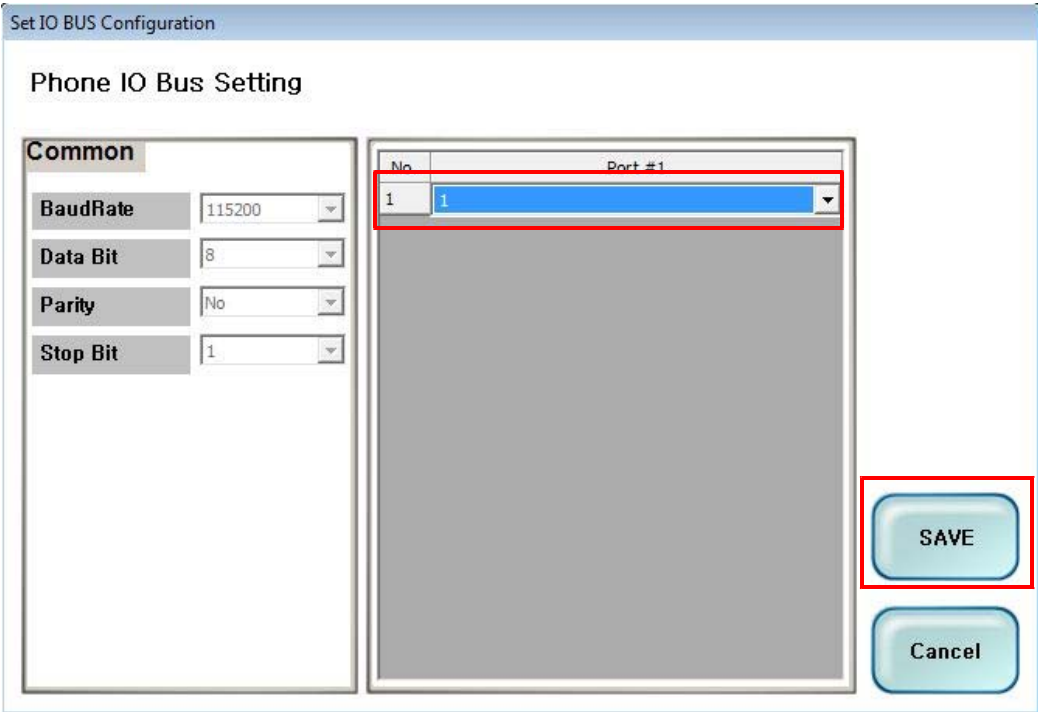

Set IO BUS Configuration

Phone IO Bus Setting

Common

BaudRate: 115200
Data Bit: 8
Parity: No
Stop Bit: 1

No.	Port #1
1	1

SAVE
Cancel

8. Click OK to proceed

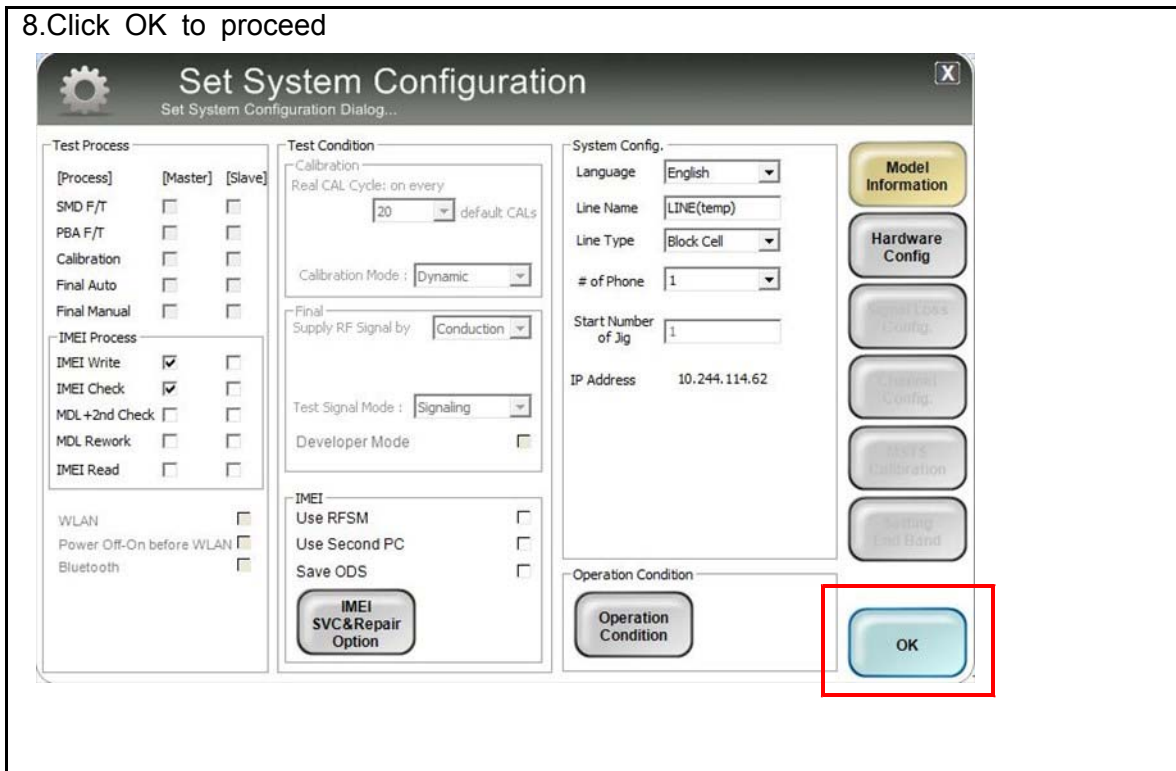

9. Click Model Info and OK when pop-up shows

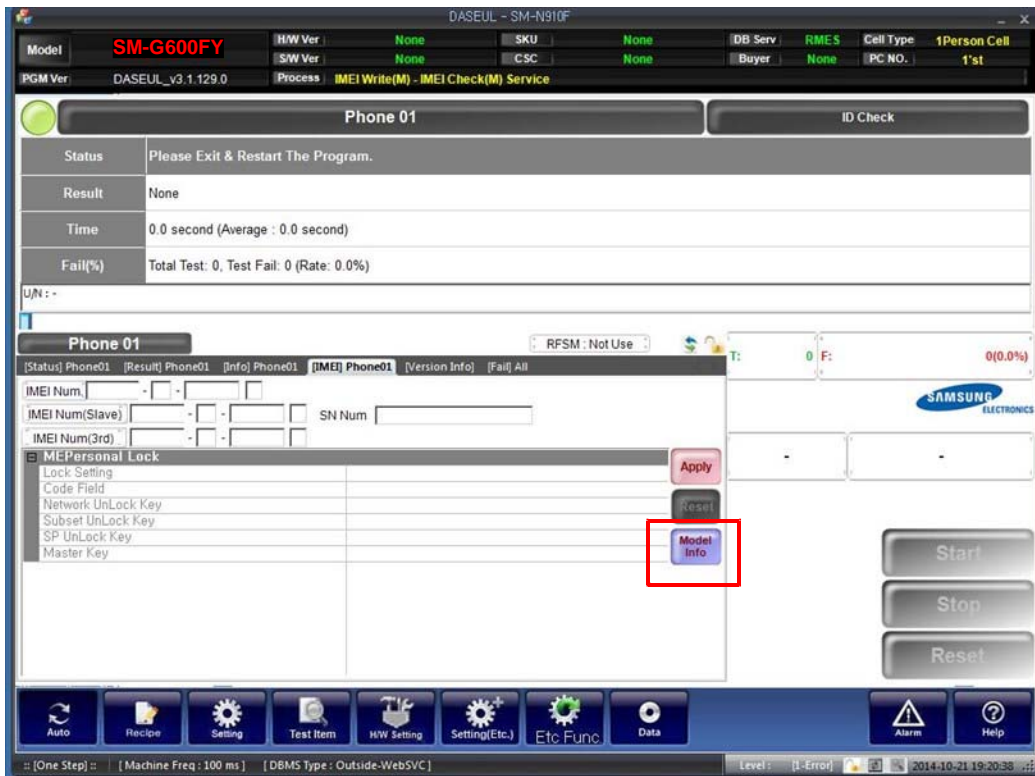

13. Click OK



14. Input SKU_CODE and BUYER, then click Save button.

※ Refer to HHPsvc→IMEI Review to check SKU Code and buyer

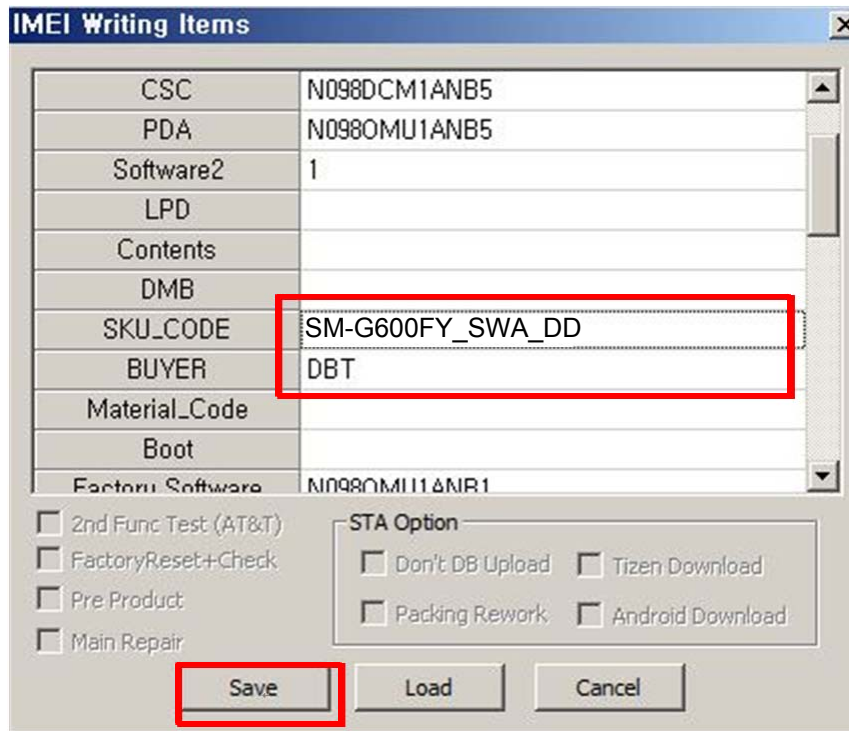

15. Input IMEI Number and click Apply

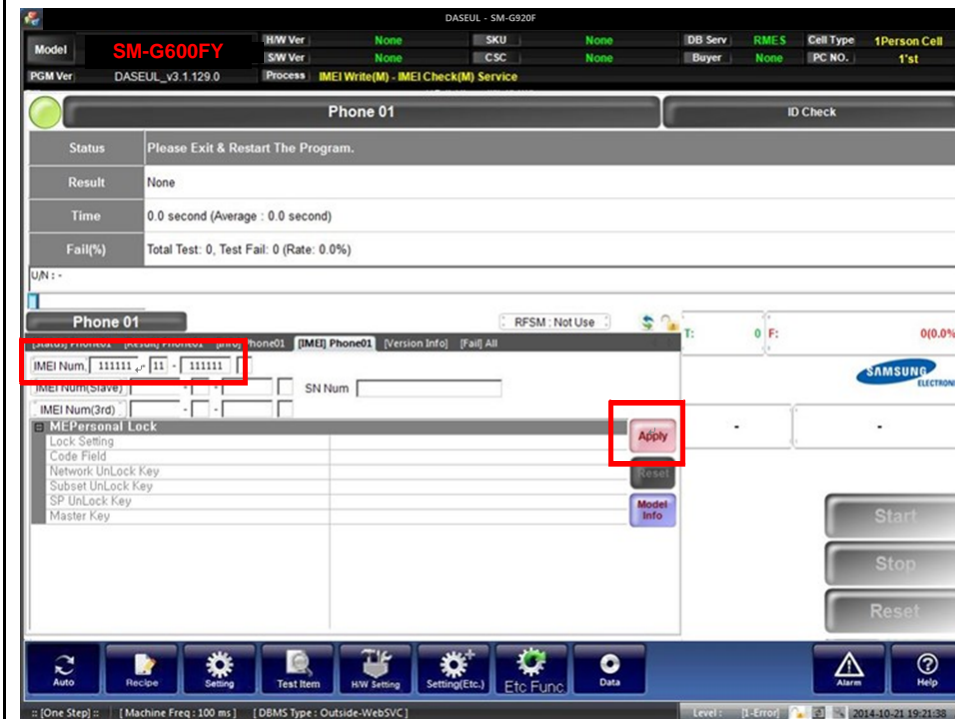

16. ① Click Start, and input IMEI writing ID and Password → ② input Ticket No

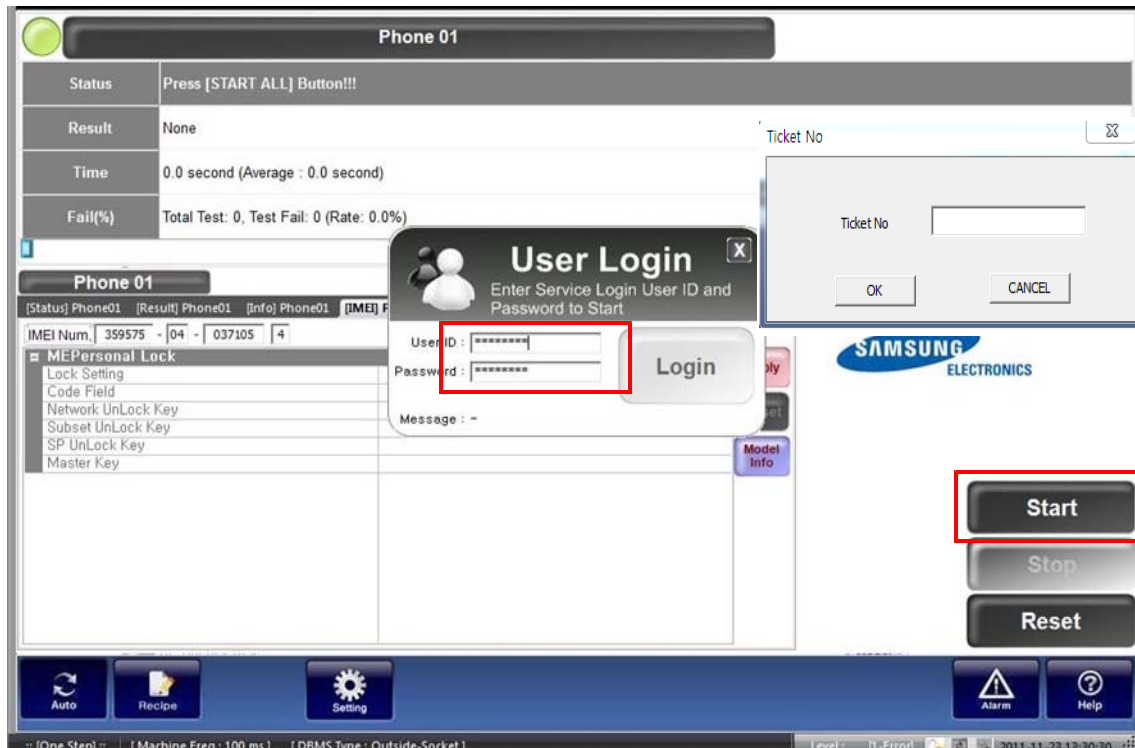

17. Connect the phone to Anyway JIG

※ When you connect the phone, the phone should be turned off.

After connecting the phone, the phone will be booted automatically.

18. IMEI Writing Proceeding

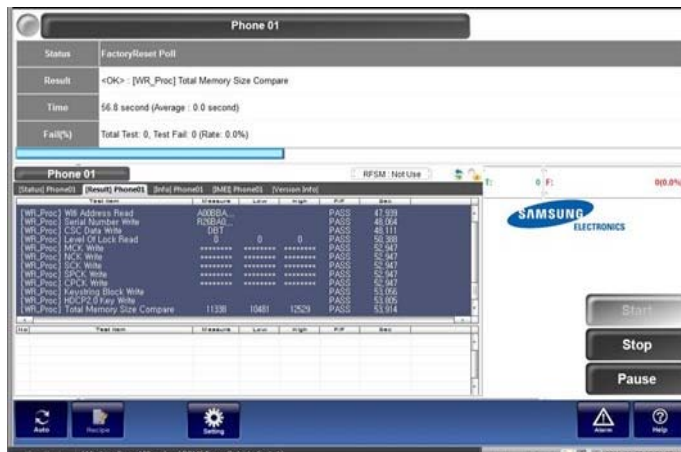

19. IMEI Writing Success

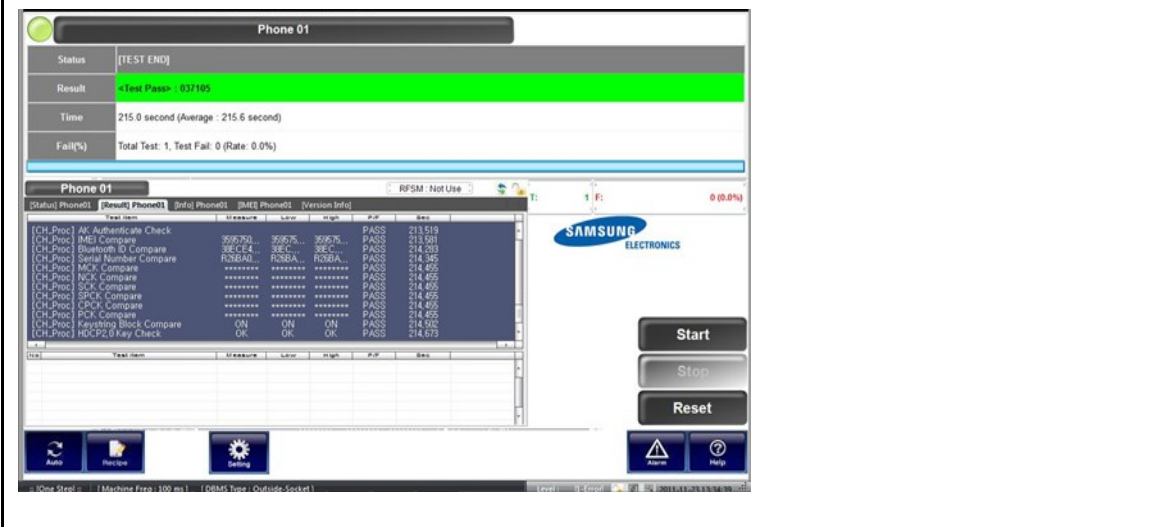

6-4. RF Calibration

6-1-1. Required items in order to calibrate RF

- Installation program: RF Calibration Program
 - Daseul_Launcher_vx.x.xx.exe
 - Daseul_CAL_ALL_Runtime_x.x.xxx.x.CAB
 - Model File (SM-XXXXX_OPEN_CALIBRATION_VER_x.x.xxx.xx.CAB)

※ It is required to use the latest program.

- Mobile Phone
- E3632A Power Supply
- JIG BOX (GH81-11888A)
- UART Serial Cable
- Table of test cables
- R&S CMW500
- GPIB Cable (2ea)
- Adapter (GH81-11888K)

IF Cable	GH81-10631A	GH81-10952A	GH81-11171A	
	11 pin	7 pin (New)	7 pin (Old)	
RF Cable (Manual)	GH81-11962D	GH81-11962G	GH81-11962C	GH81-11962F
	1.35T, 500mm 	1.35T, 1750mm 	1.6T, 400mm 	1.6T, 1700mm 
4 Port Divider	GH81-11962A	GH81-11962B	GH81-11962E	
	Divider 	Divider Cable 	50Ω terminator 	

※ Setting

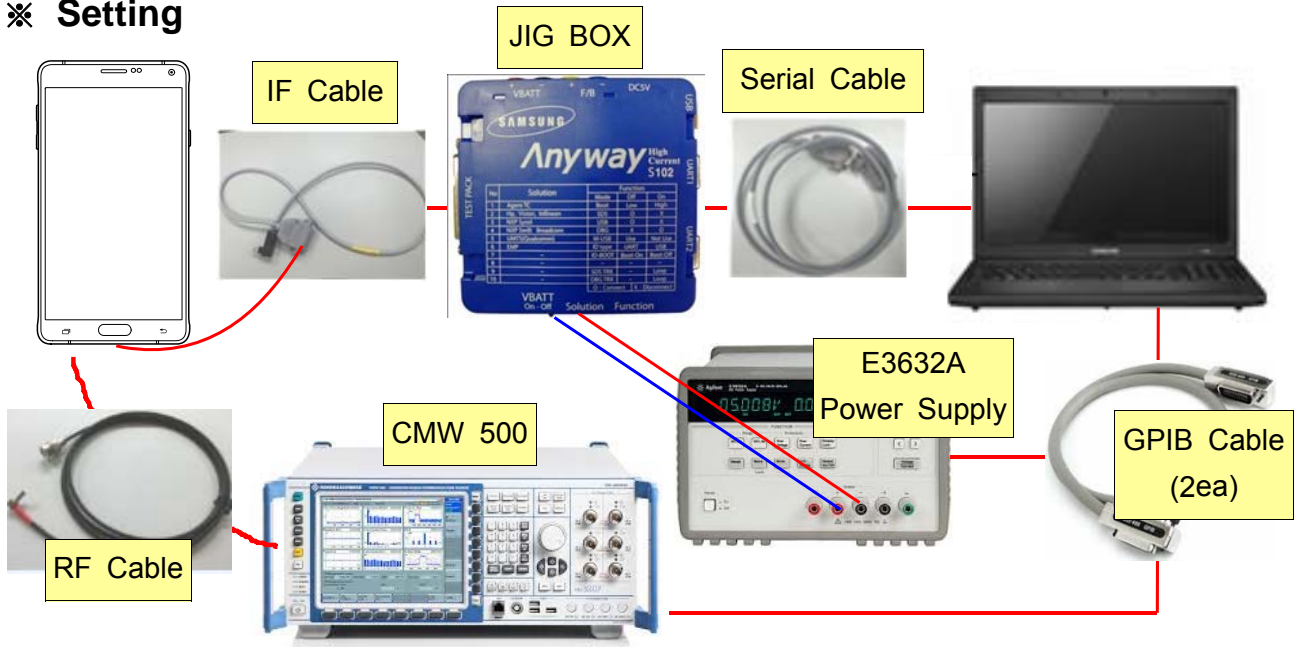

6-1-2. RF Calibration Program

1. Run the RF Calibration Program Launcher, 'DASEUL_Launcher_vx.x.xx.exe'.

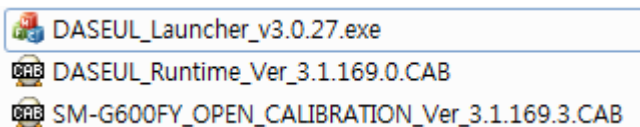

2. Check the 'Calibration' menu, and select 'Extract & Run'.

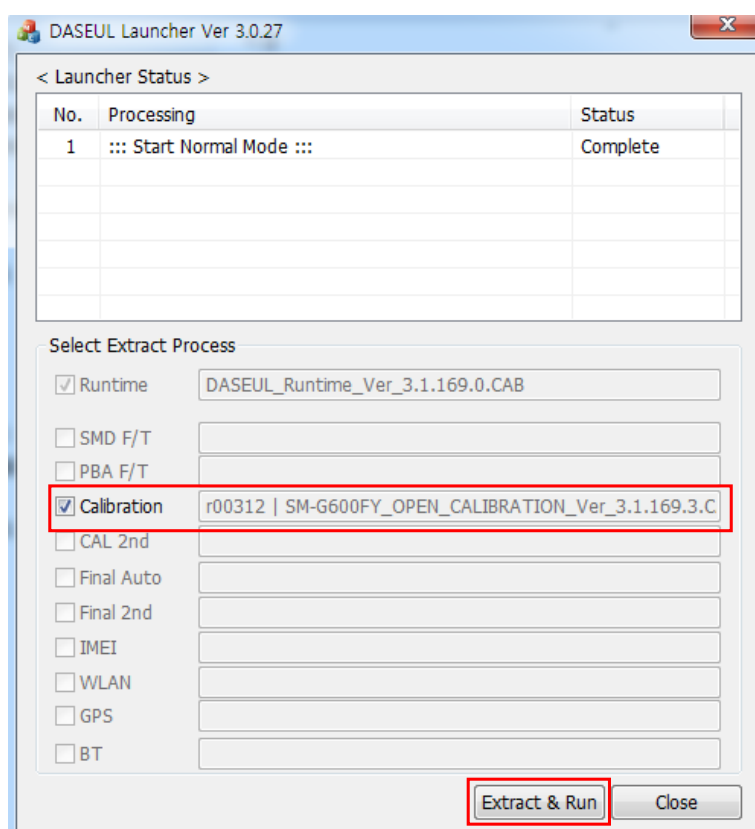

3. Check the 'CAL' and open the model file, then select 'Start' button.

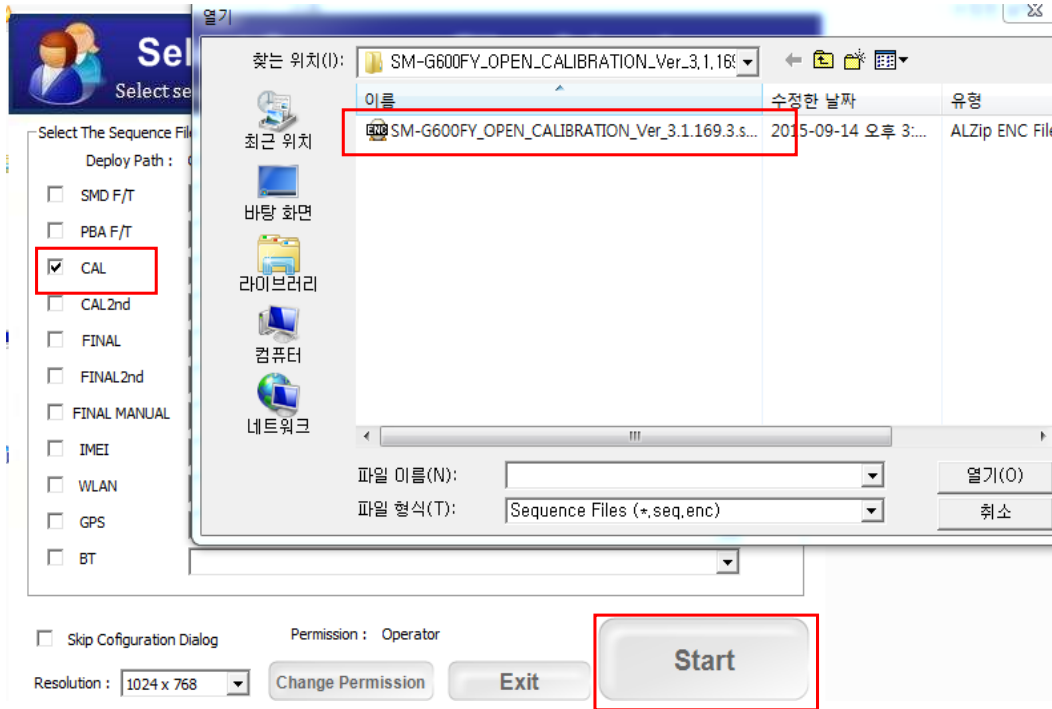

4. Change the Line Type to 'Block Cell' and disable 'Smart Cloud Cell'.

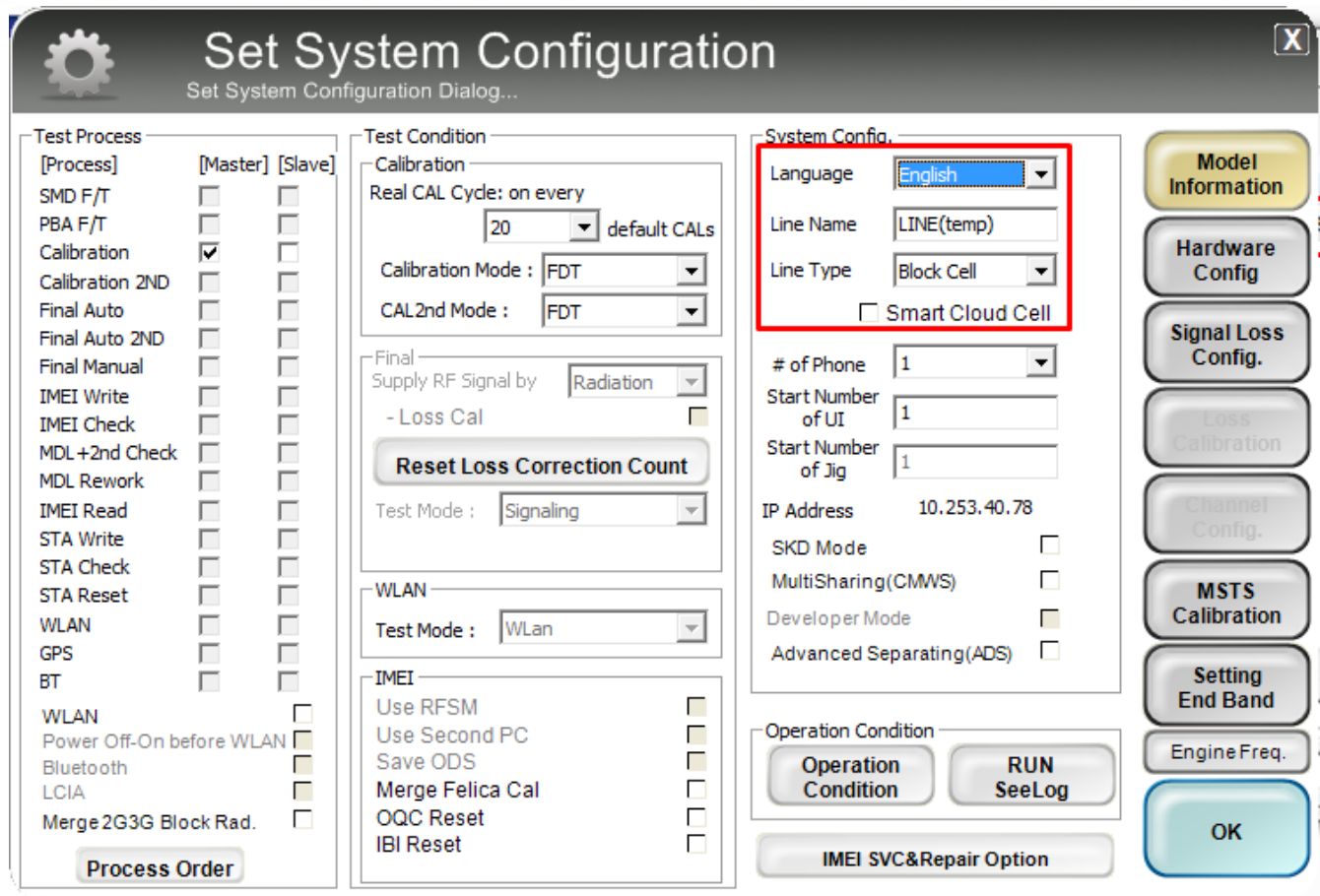

- Set the GPIB address of MSTs(CMW500) and Power Supply(E3632A) to enter 'Hardware Config' and 'Save'. (Check the GPIB address of equipments in advance)

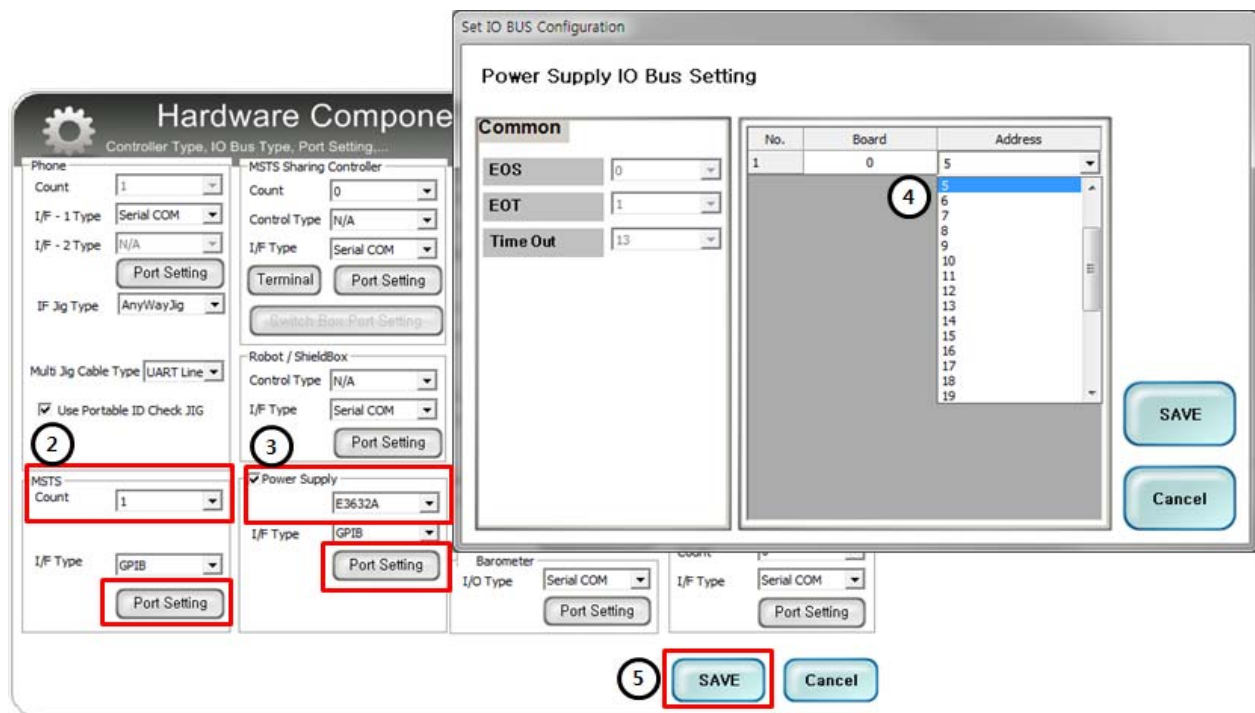
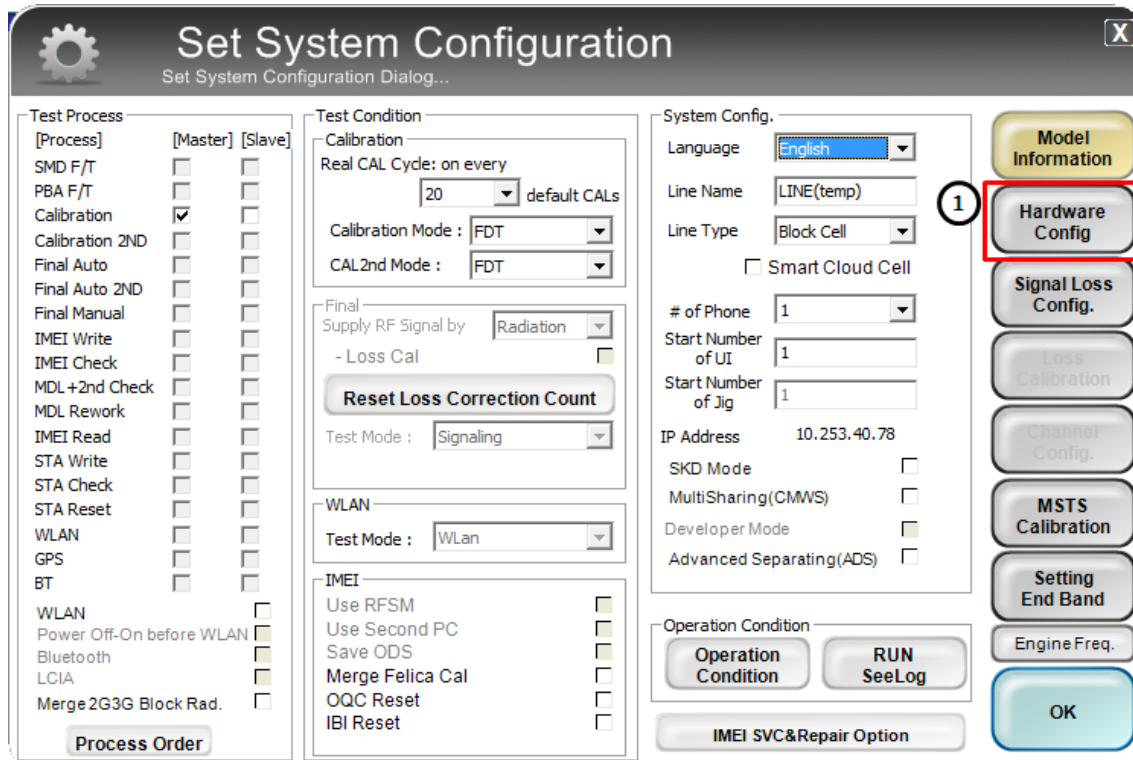

6. Press 'OK' to start RF Calibration after completing all settings.

