

SM-C900F/DS Block Diagram



SM-C900Y/DS Block Diagram



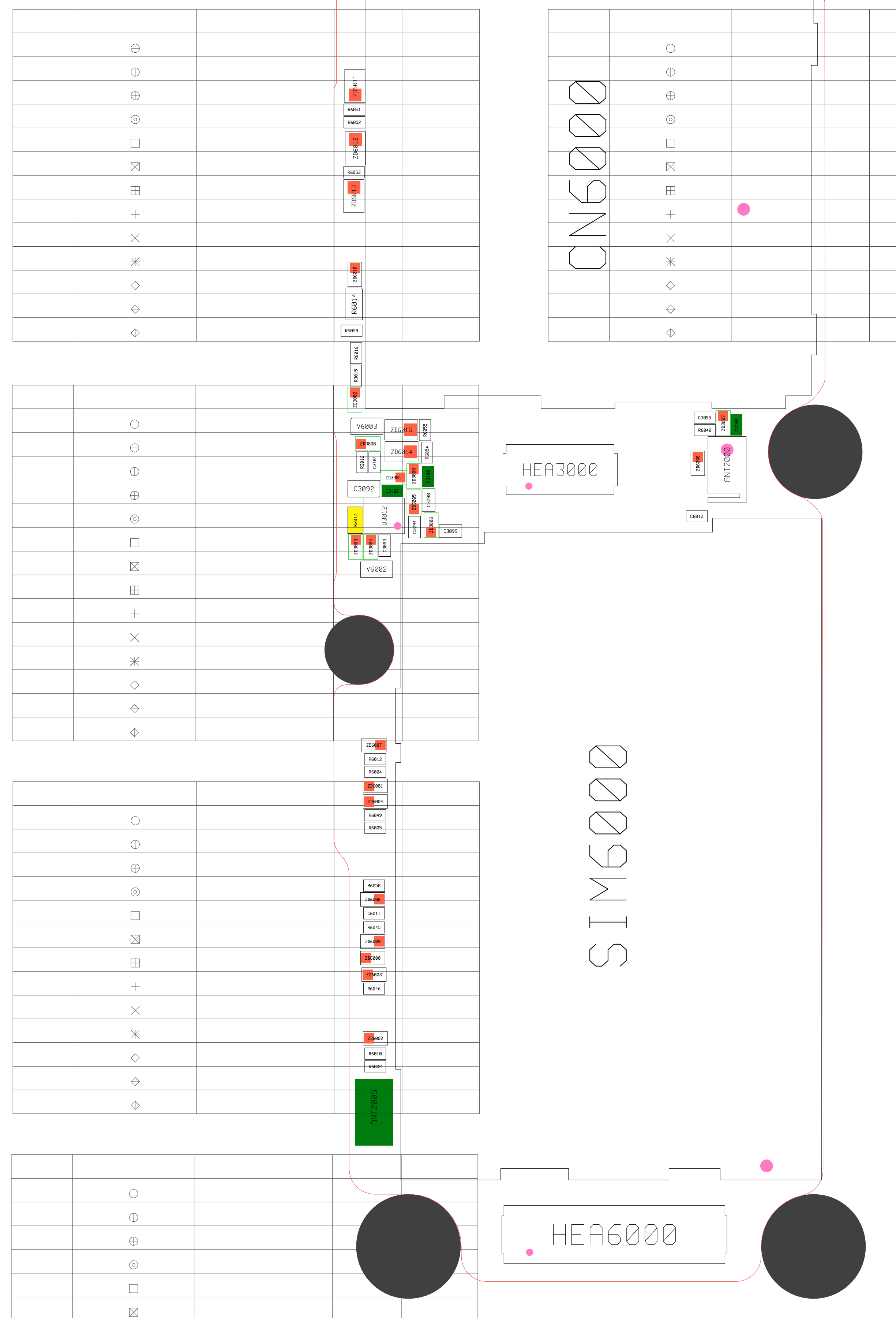
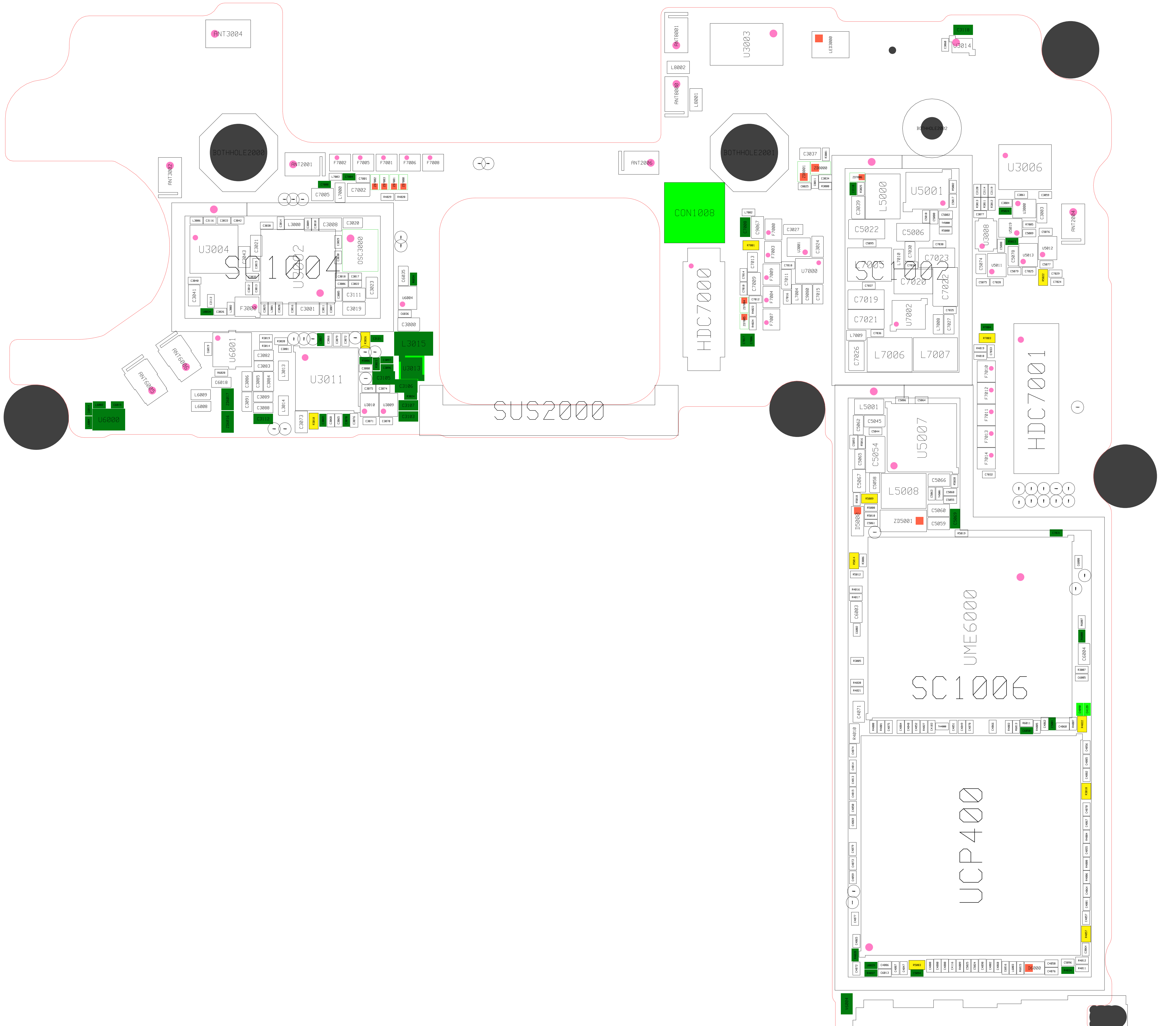

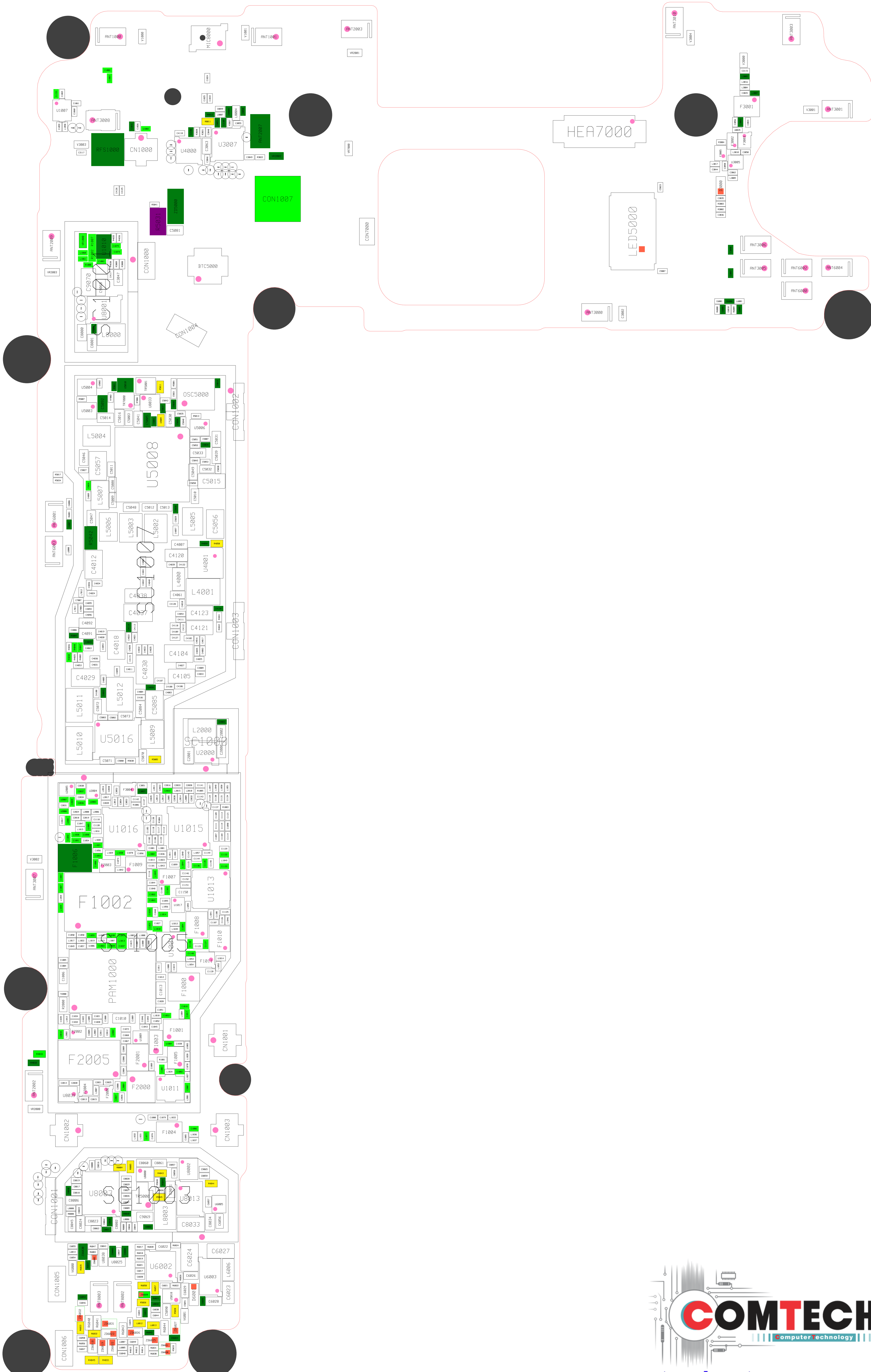



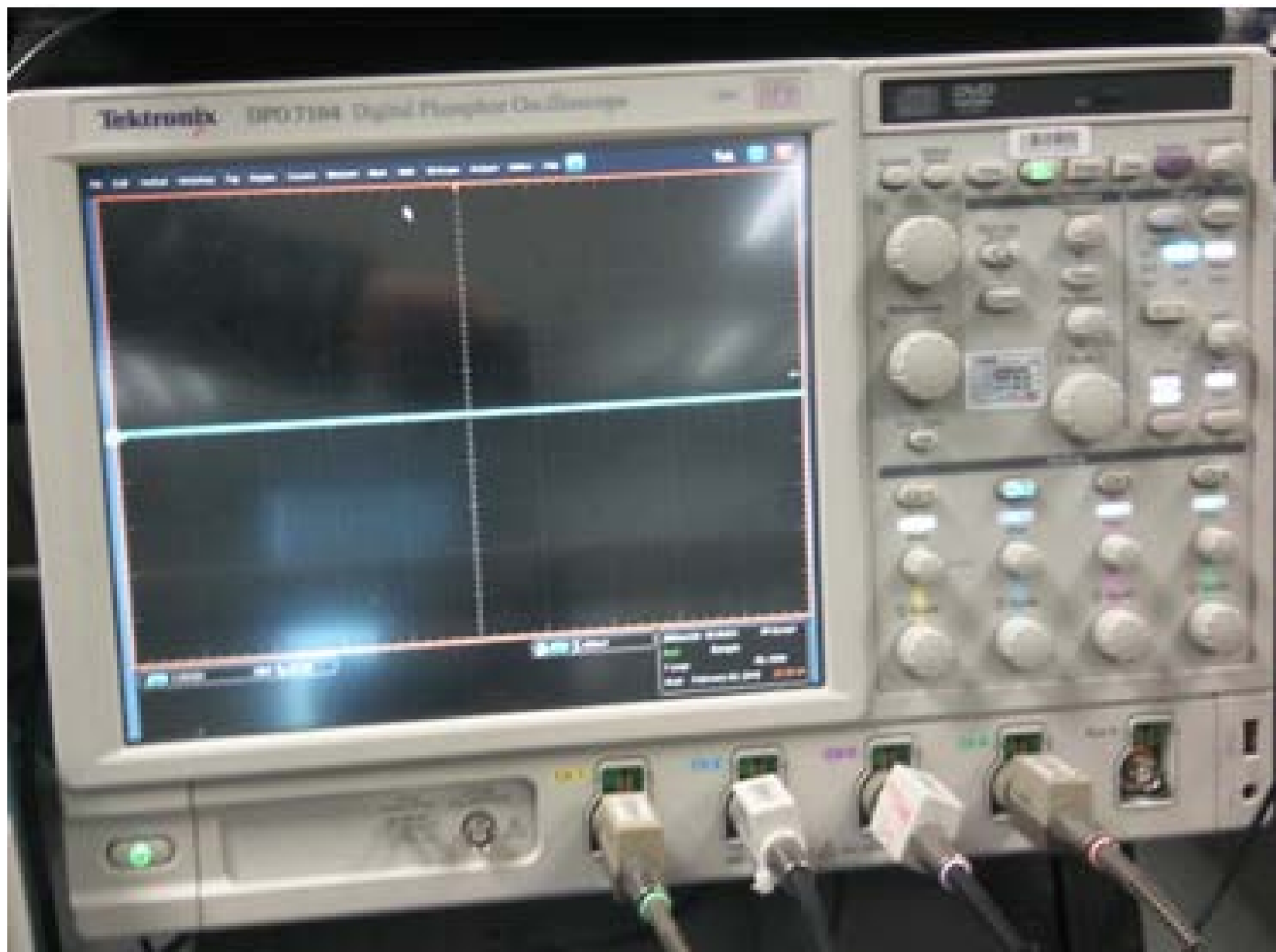

8. Level 3 Repair

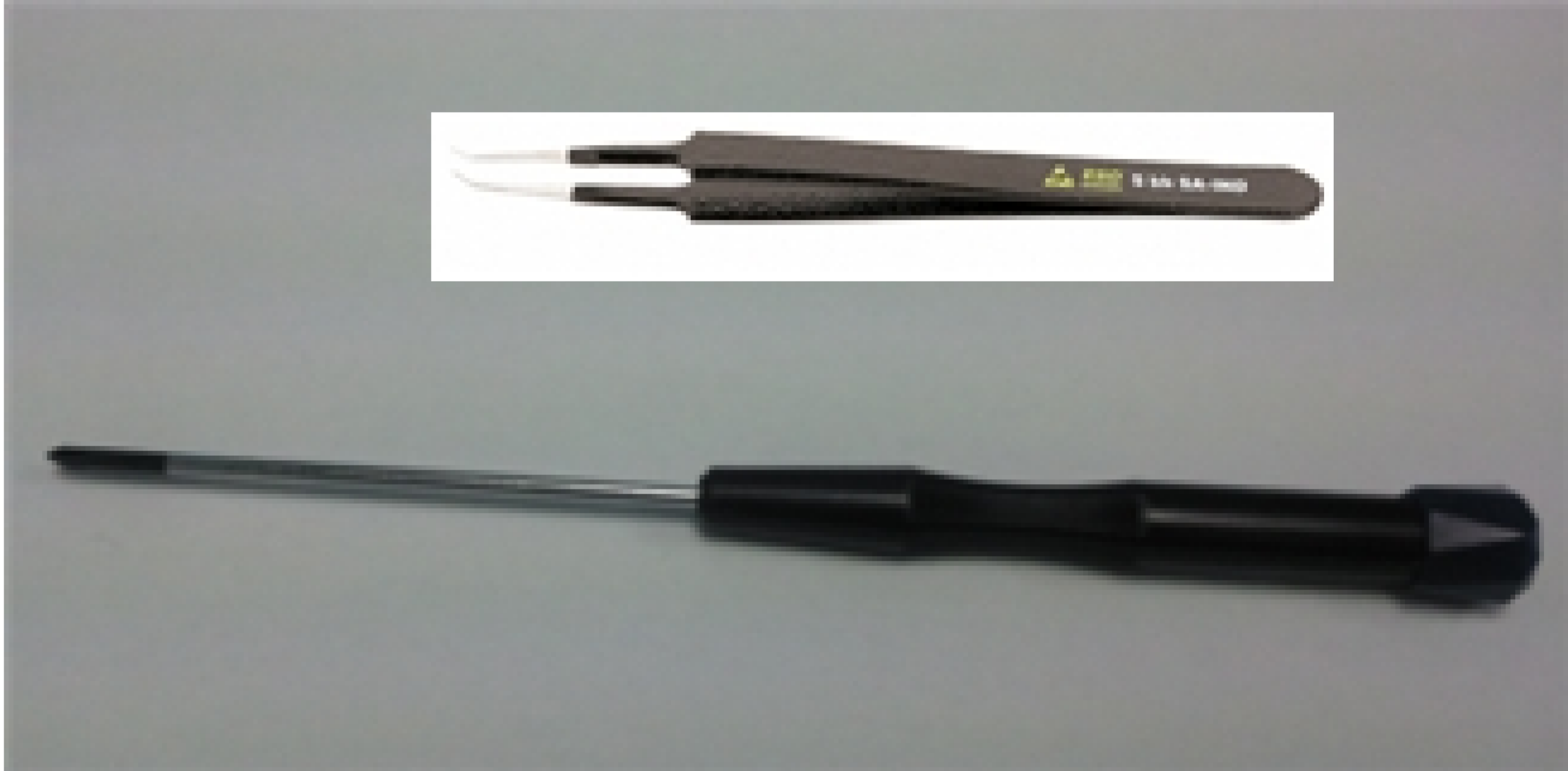
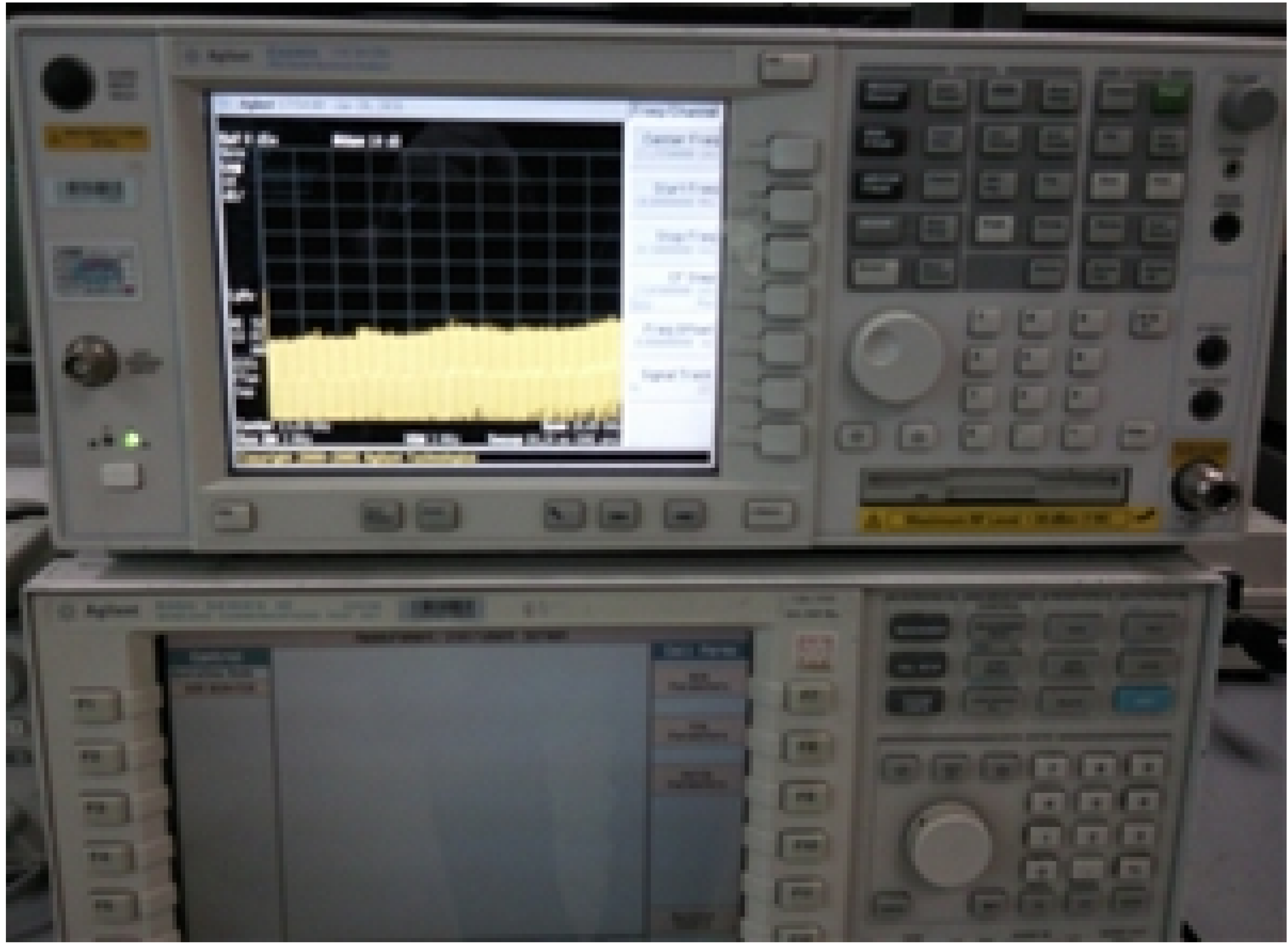
8-3. Flow Chart of Troubleshooting

	
<p>Oscilloscope</p>	<p>Digital Multimeter</p>
	
<p>Power Supply</p>	<p>+ driver, ESD Safe Tweezer</p>
	
<p>8960 & Spectrum Analyzer</p>	<p>Soldering iron</p>

8. Level 3 Repair

8-3-1. Power On

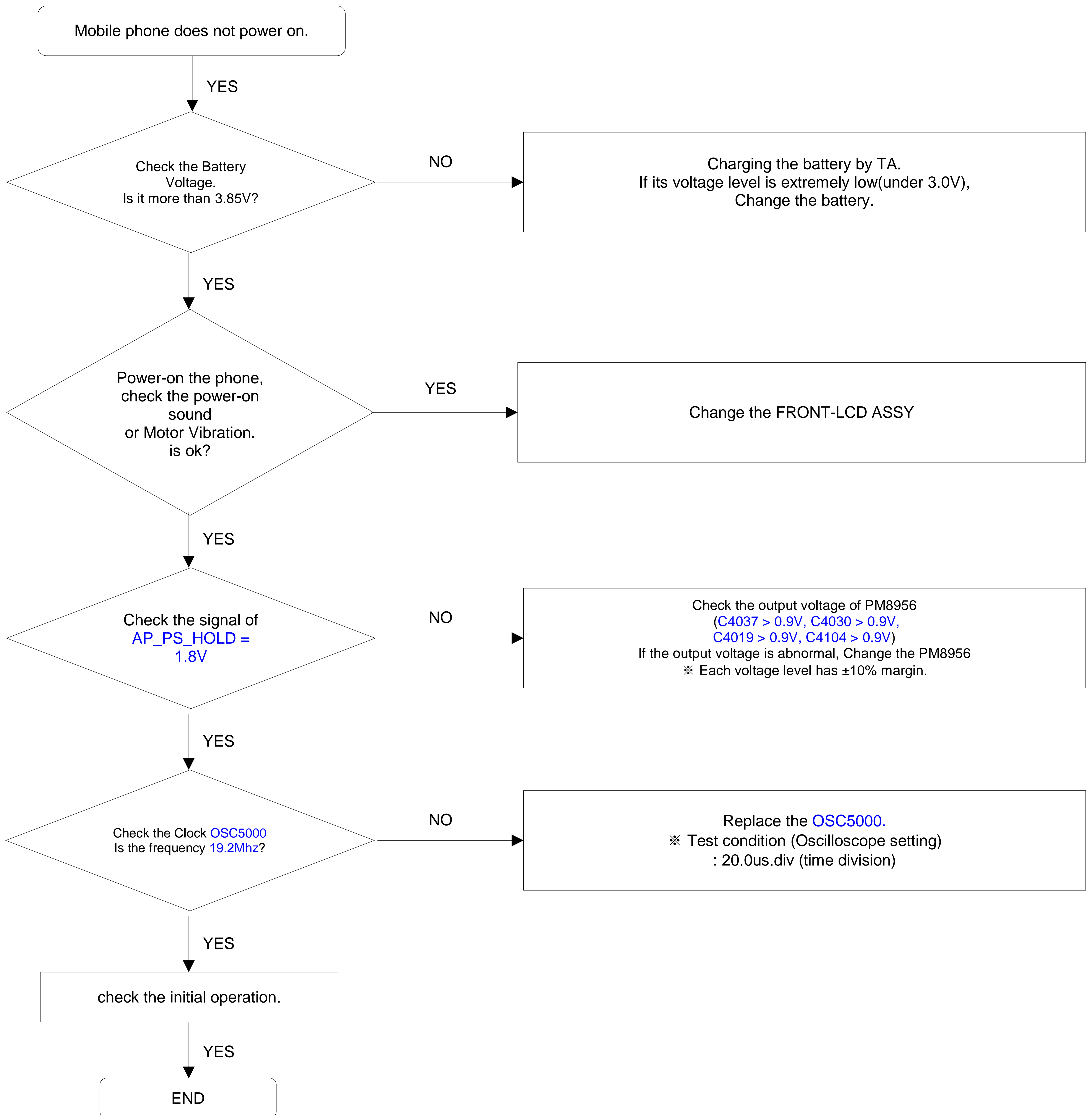

8. Level 3 Repair

8-3-2. Initial

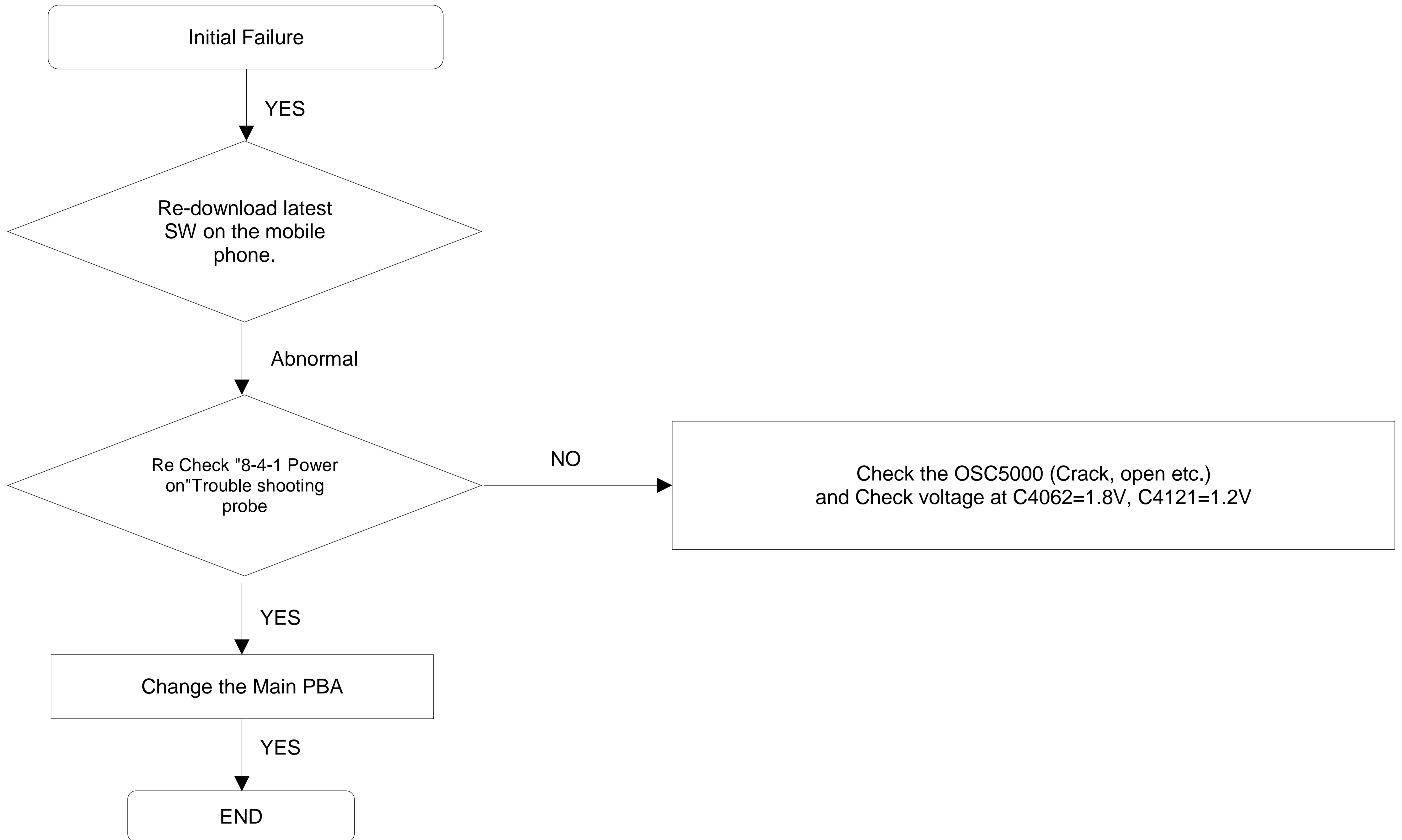

8. Level 3 Repair

8-3-3. No Service

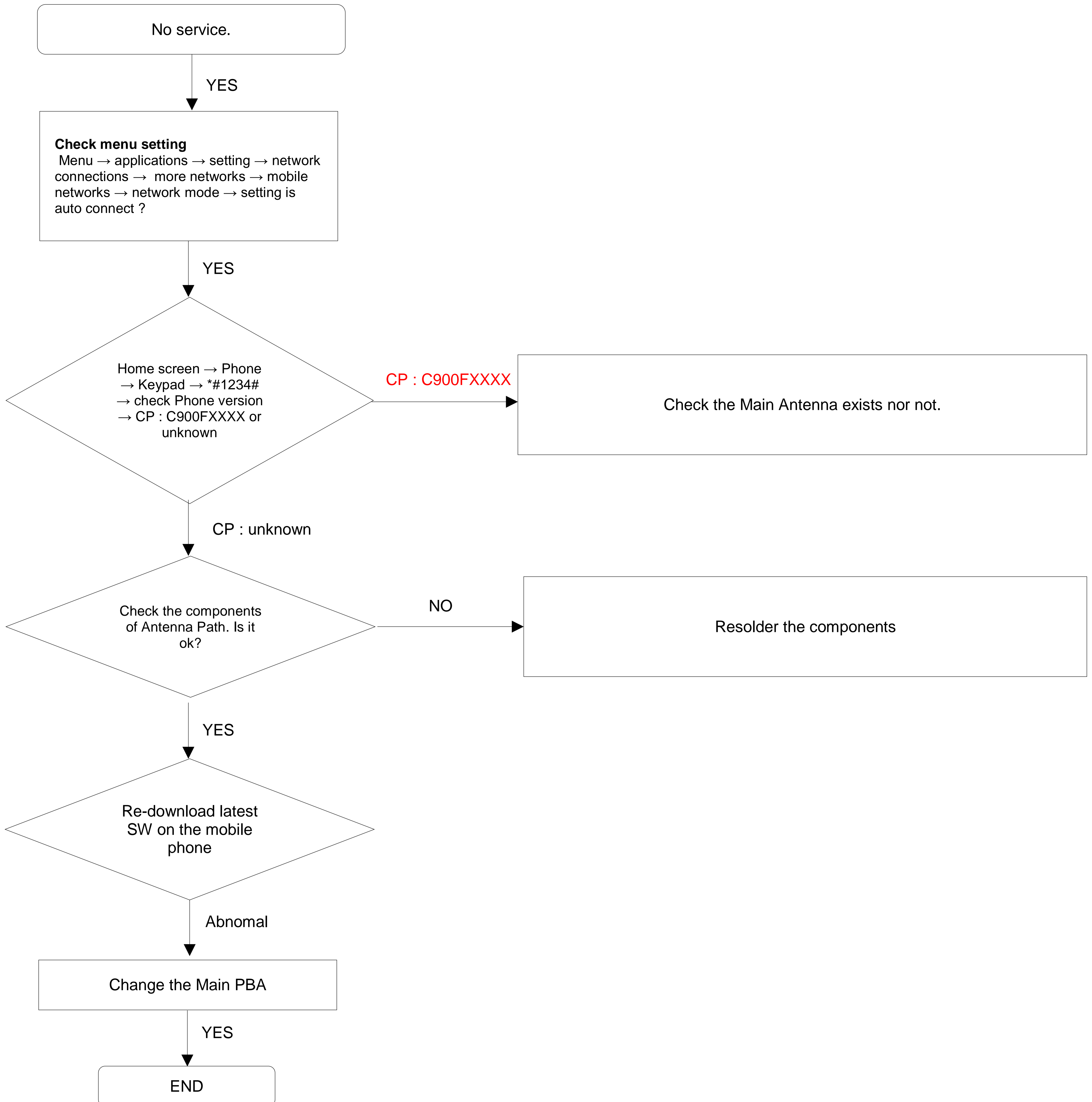

8. Level 3 Repair

8-3-4. Sim Part

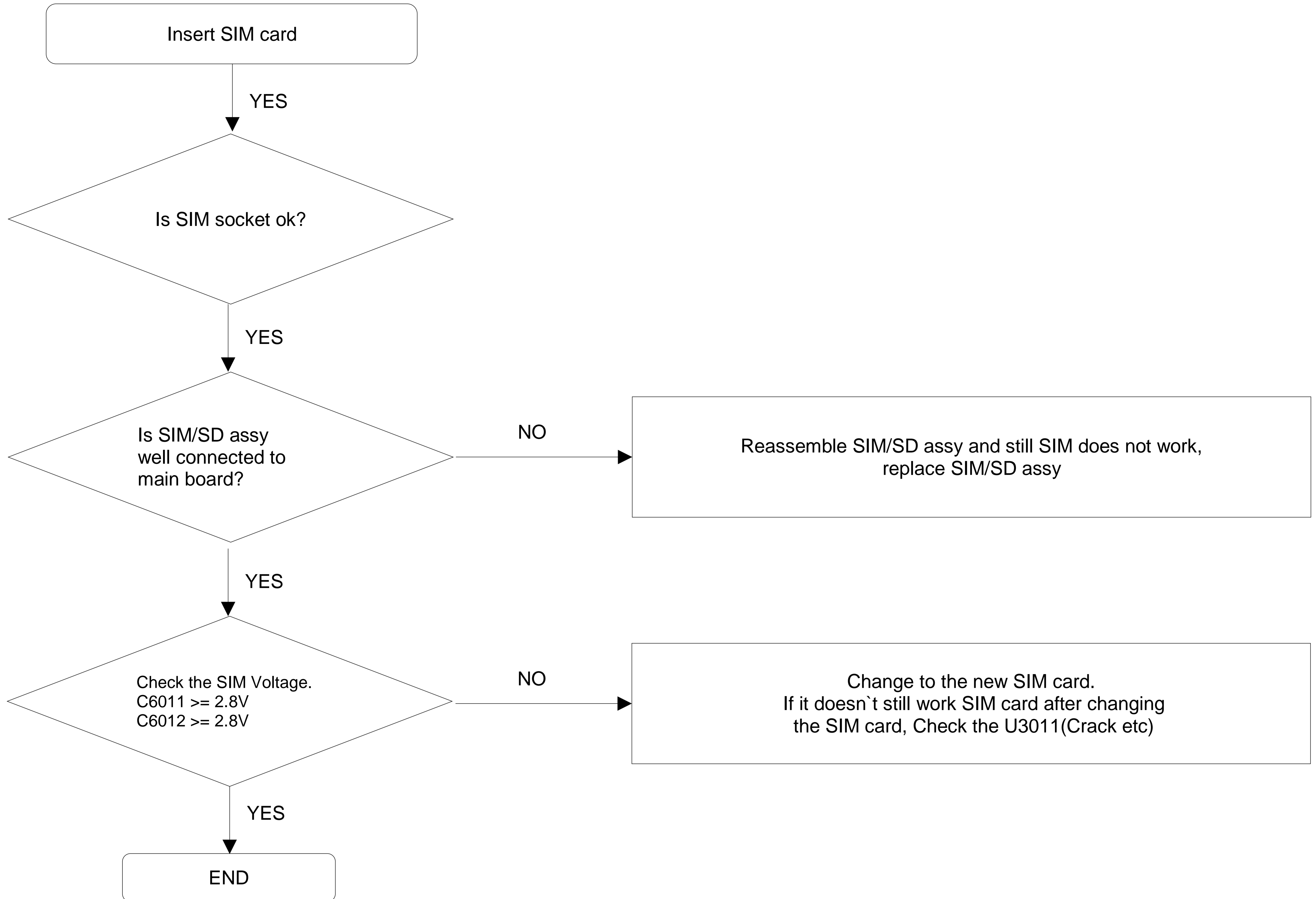

8. Level 3 Repair

8-3-5. Charging Part

- First of all, Please check the battery status.

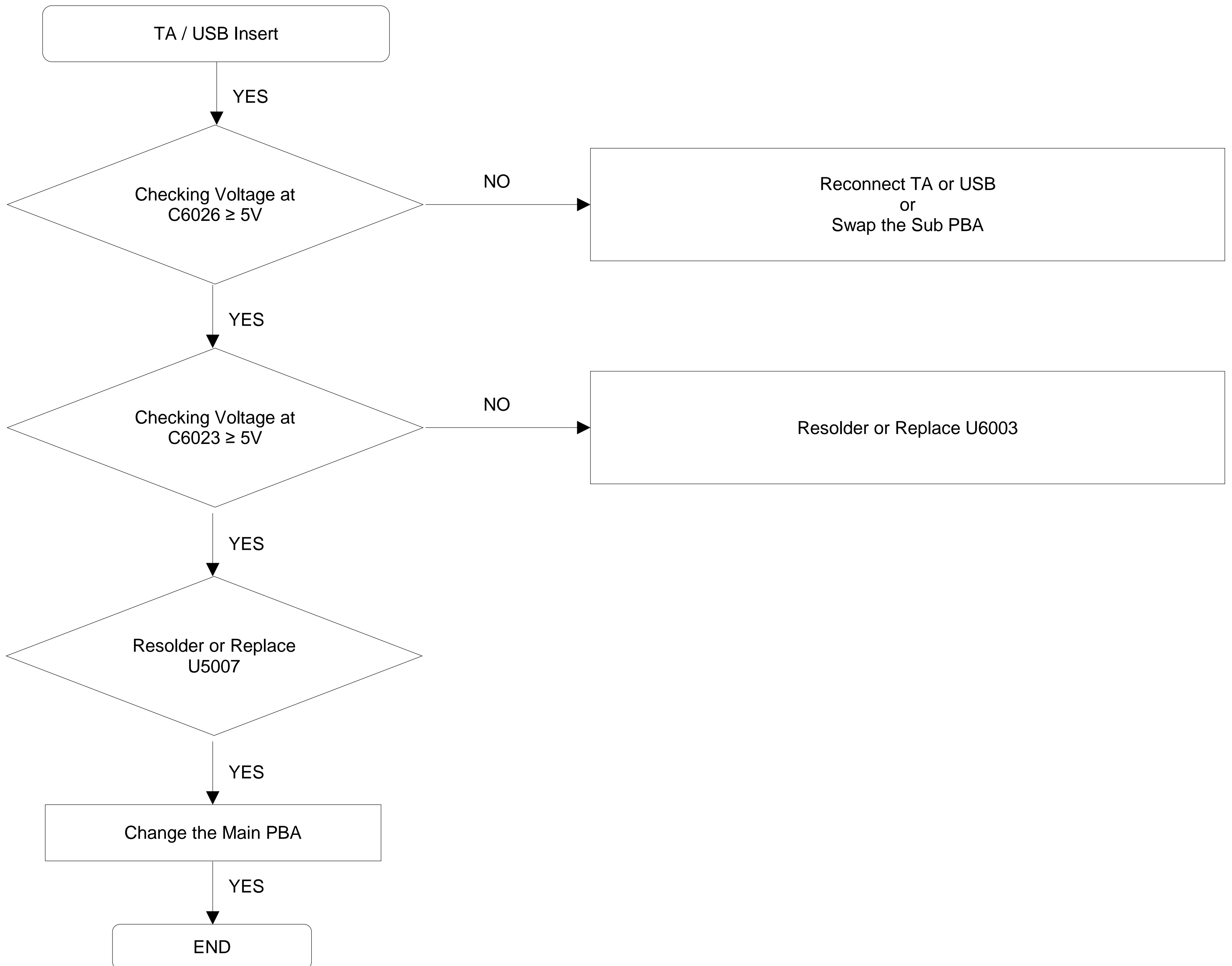

8. Level 3 Repair

8-3-6. Microphone Part

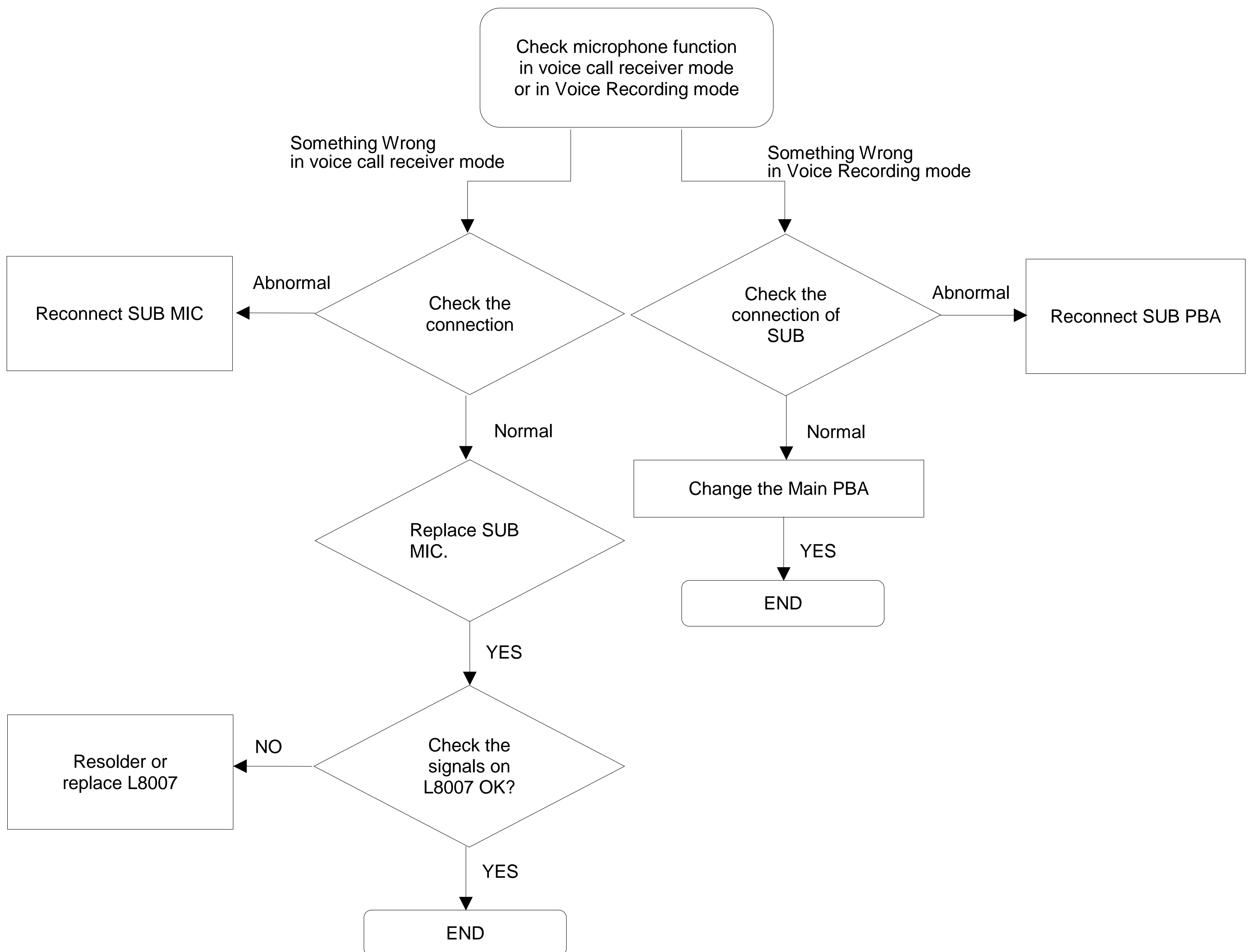

8. Level 3 Repair

8-3-7. Speaker Part

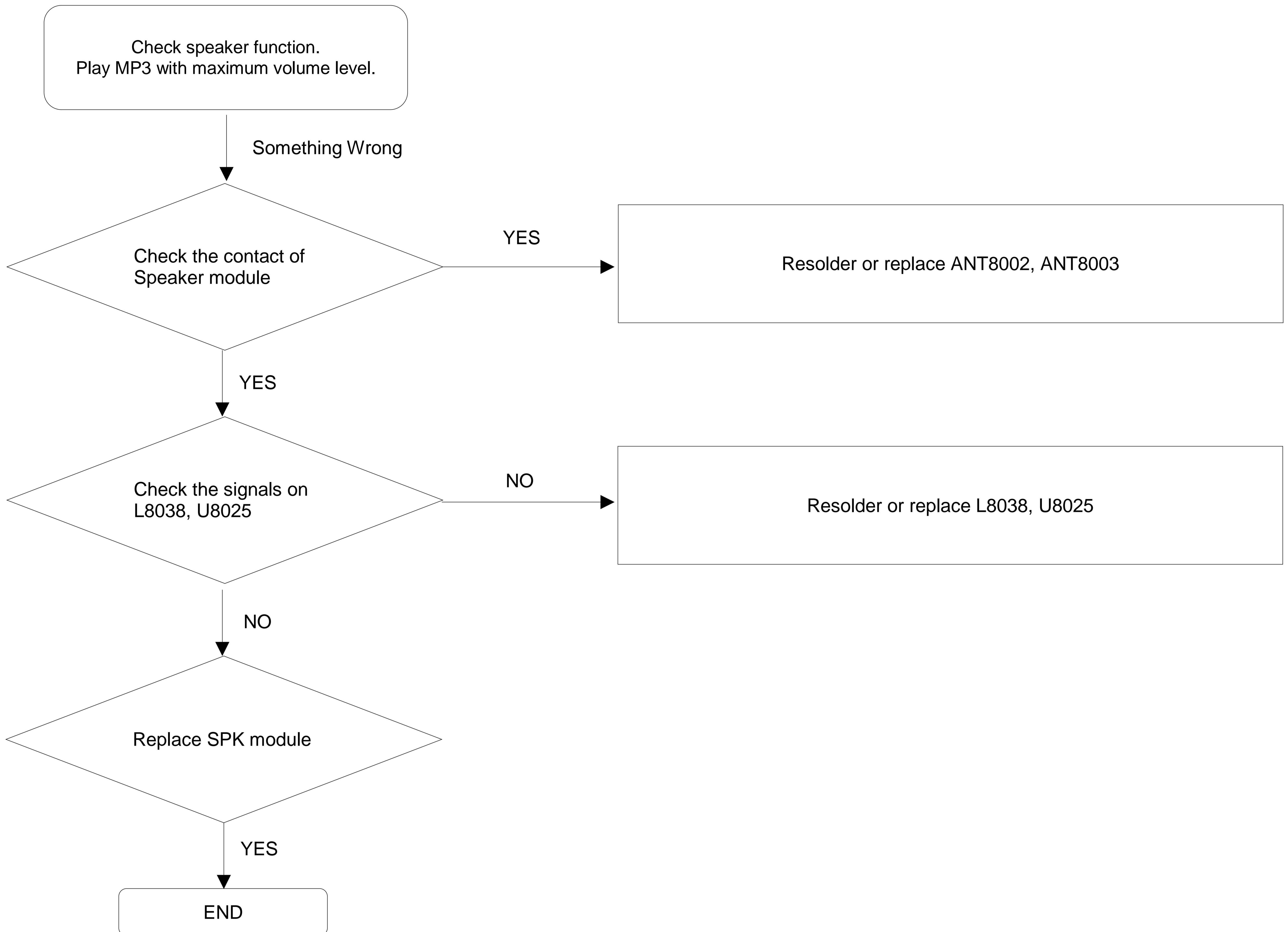

8. Level 3 Repair

8-3-8. Receiver Part

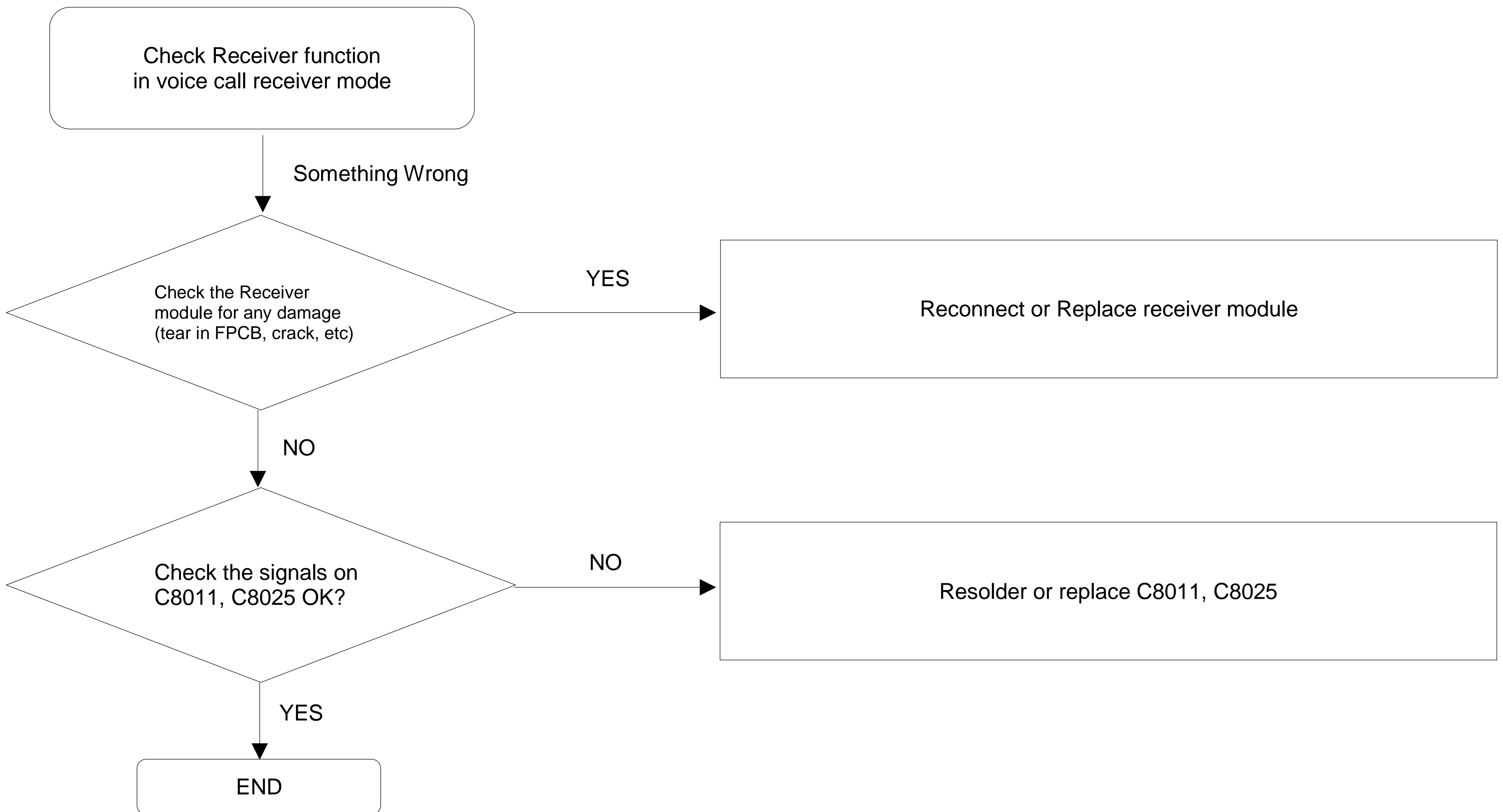

8. Level 3 Repair

8-3-9. OCTA

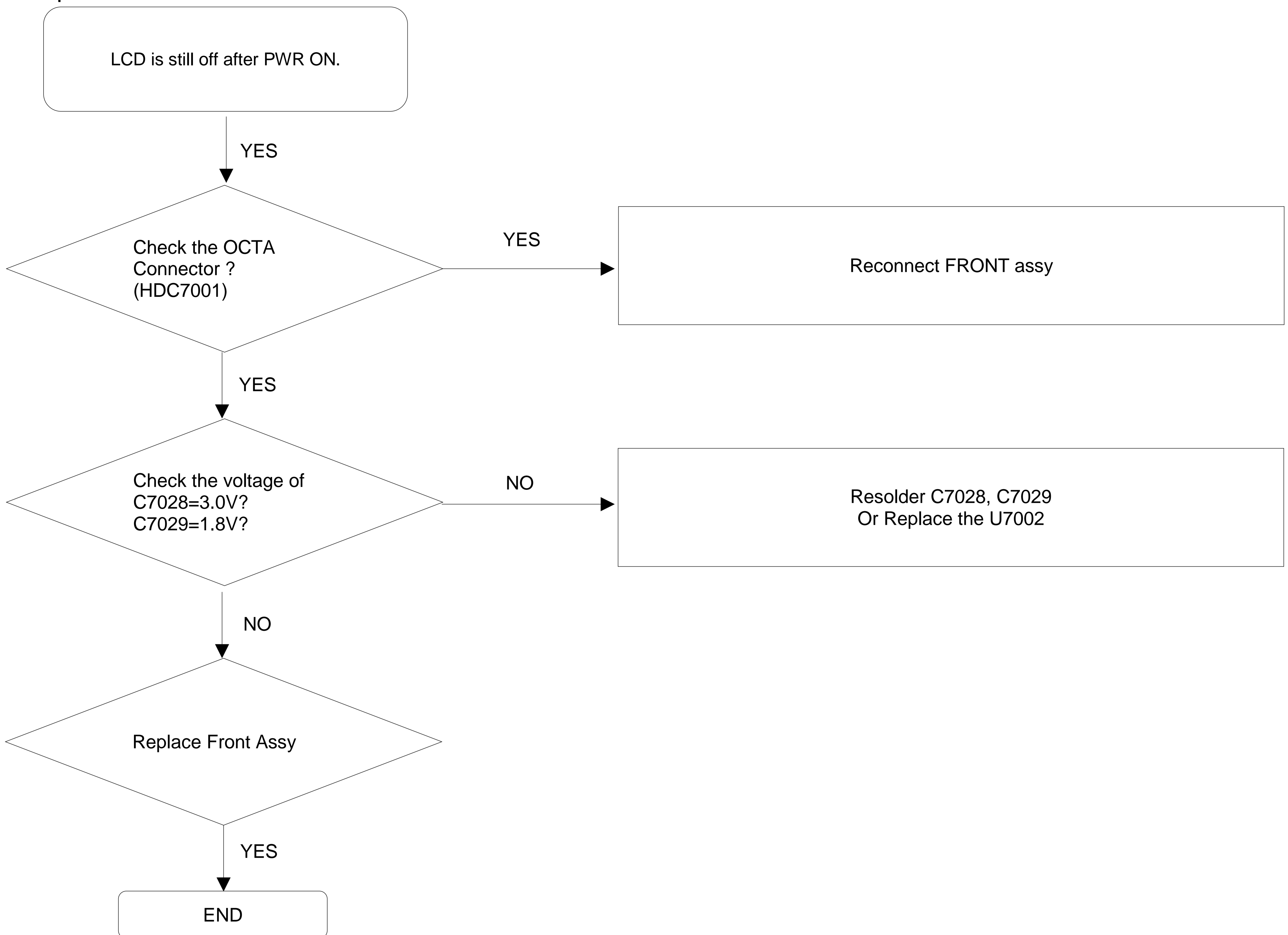

8. Level 3 Repair

8-3-10. 16M(Main) CAMERA

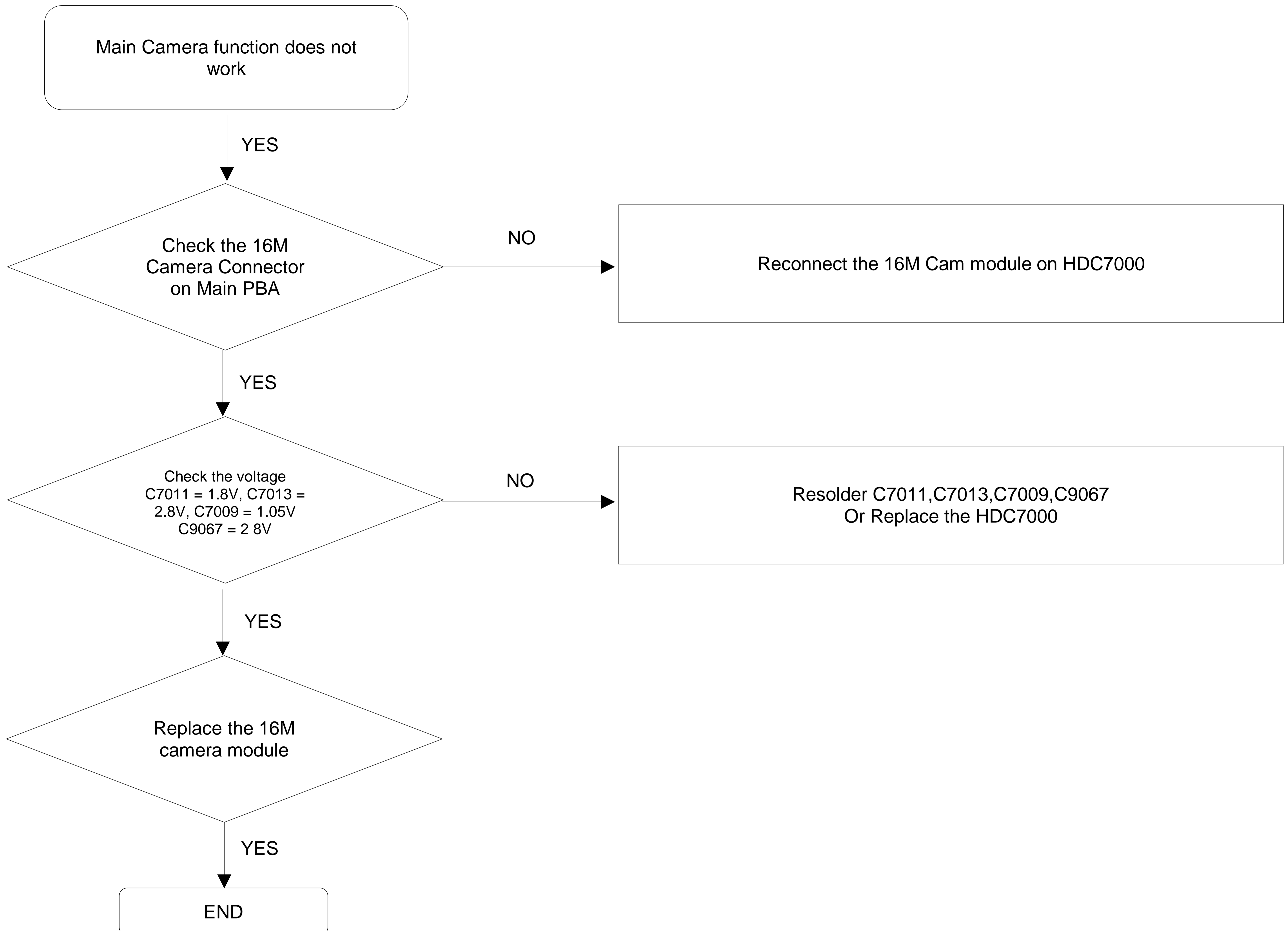

8. Level 3 Repair

8-3-11. 16M(Front) CAMERA

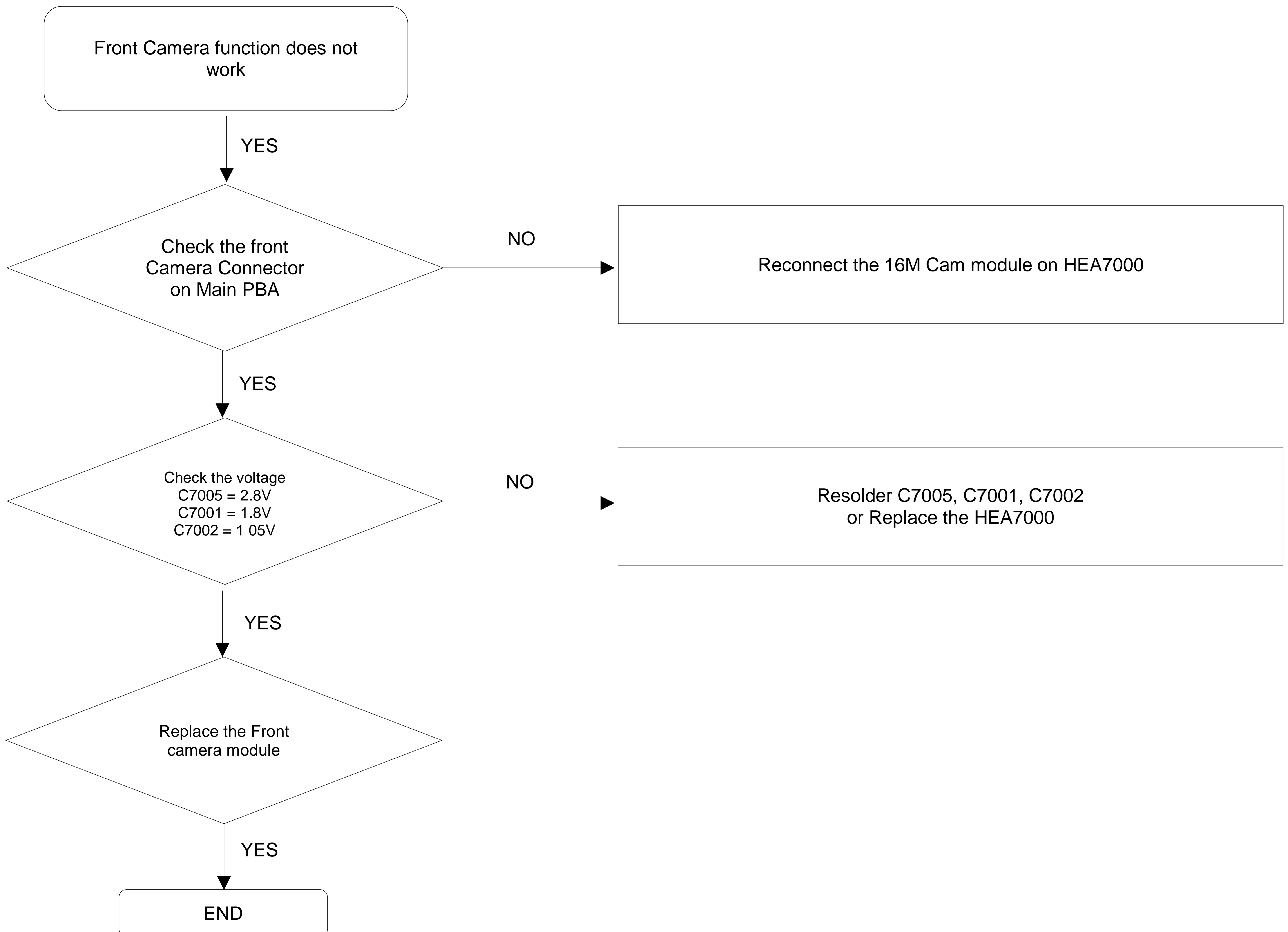

8. Level 3 Repair

8-3-12. RF Section(LTE, WCDMA, TSCDMA, CDMA, GSM)

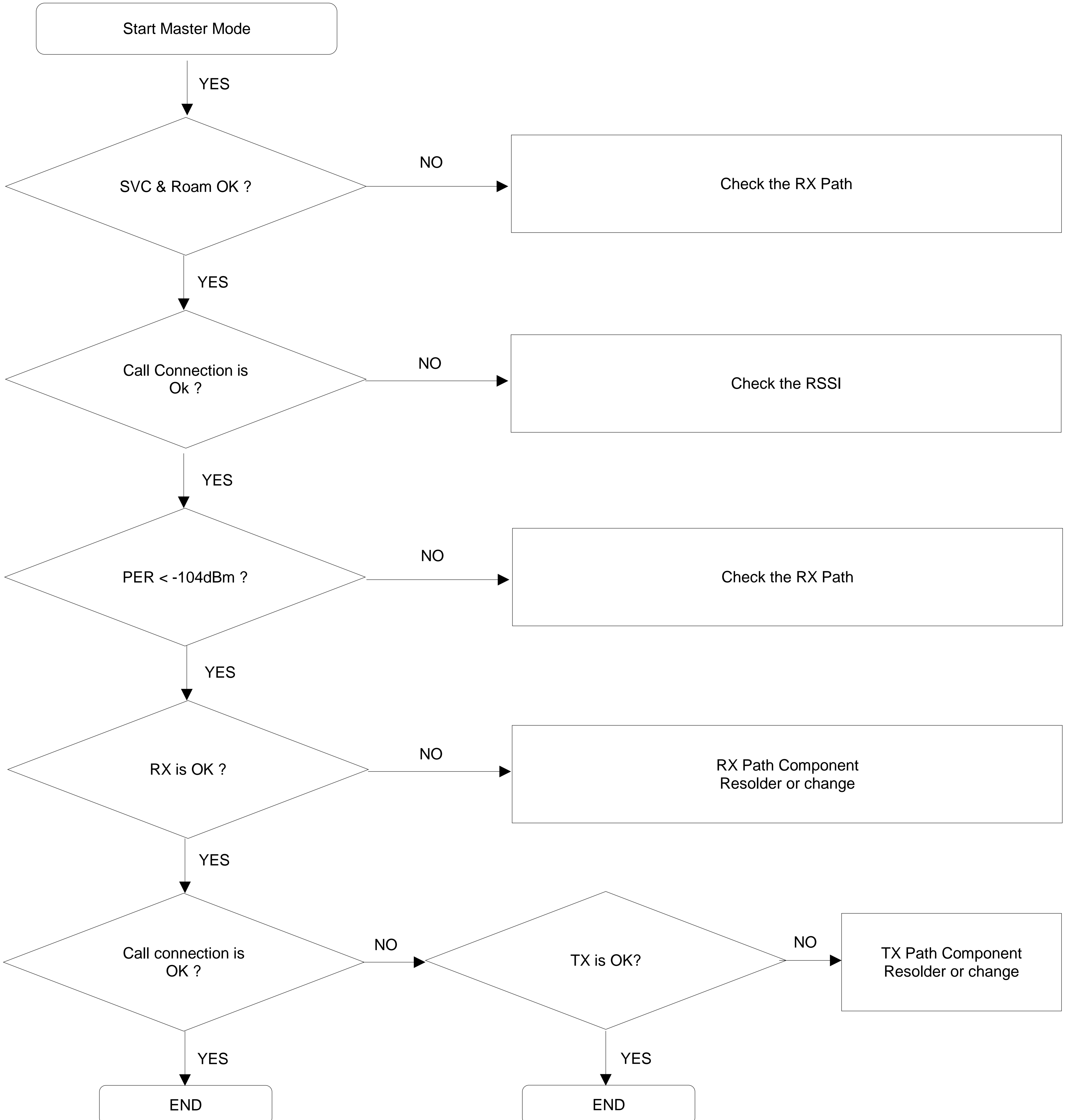

8. Level 3 Repair

8-3-13. RF Section(WLAN / BT)

- WLNA RX

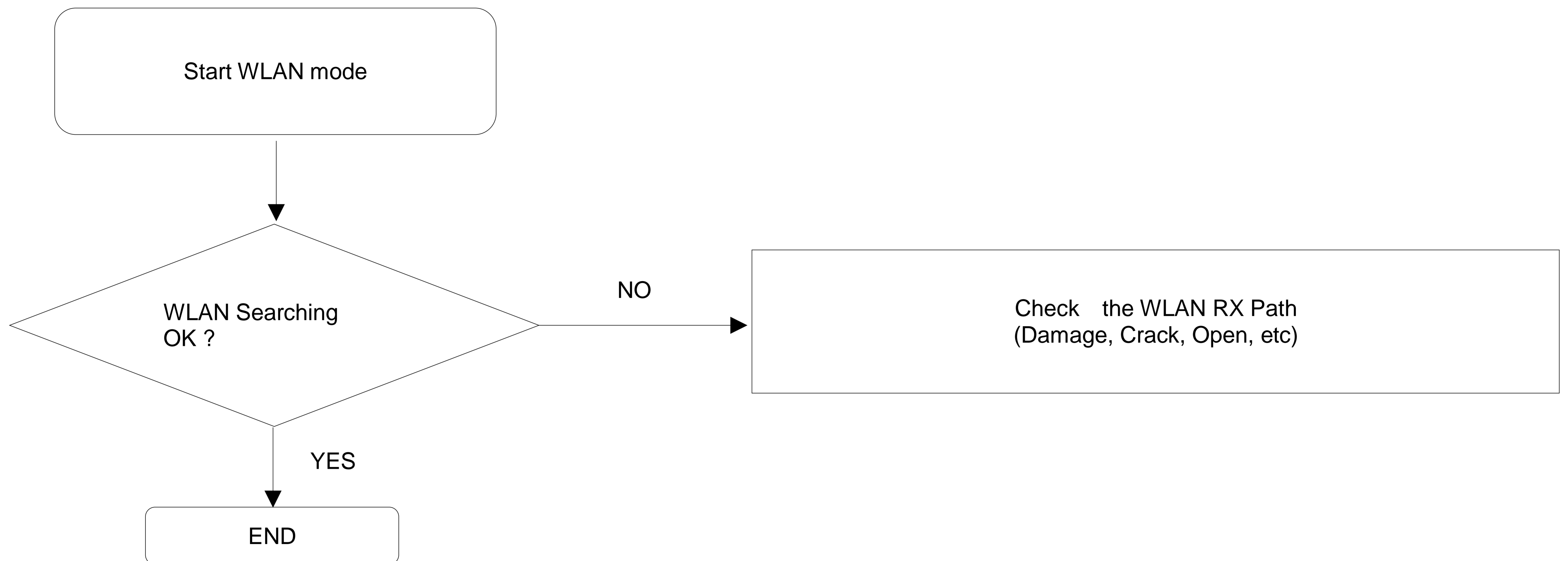

- WLNA TX

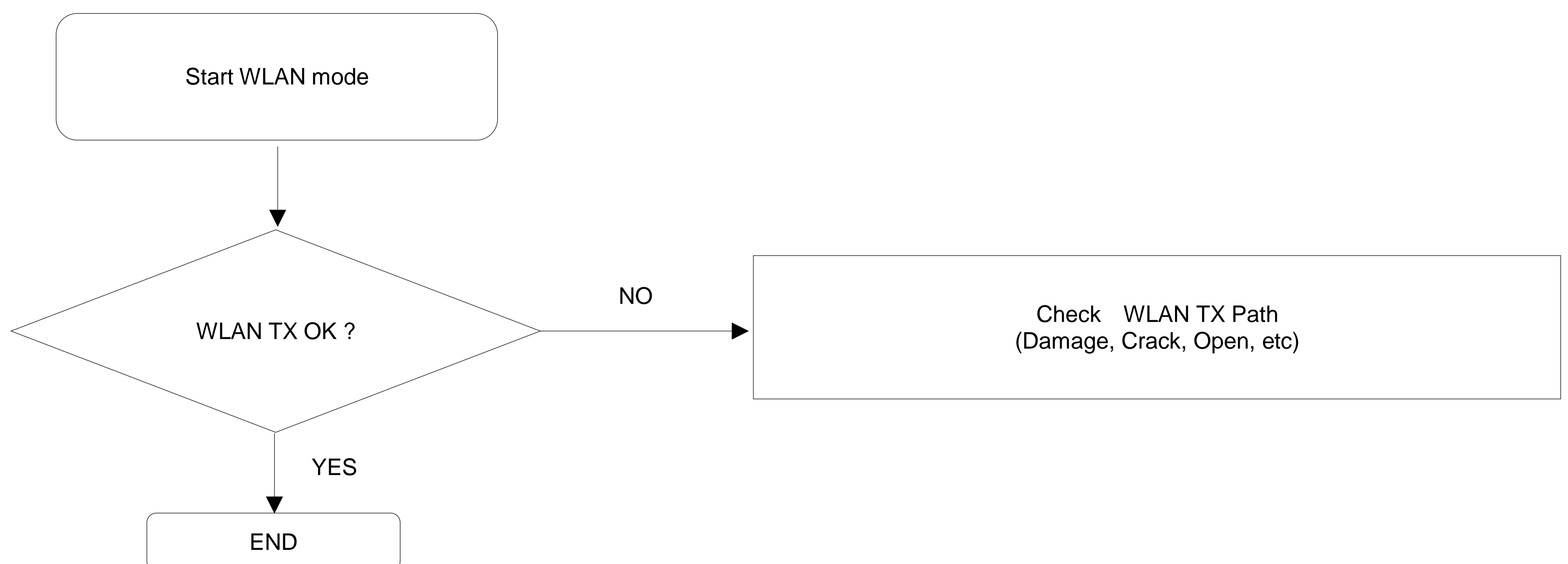

8. Level 3 Repair

- BT

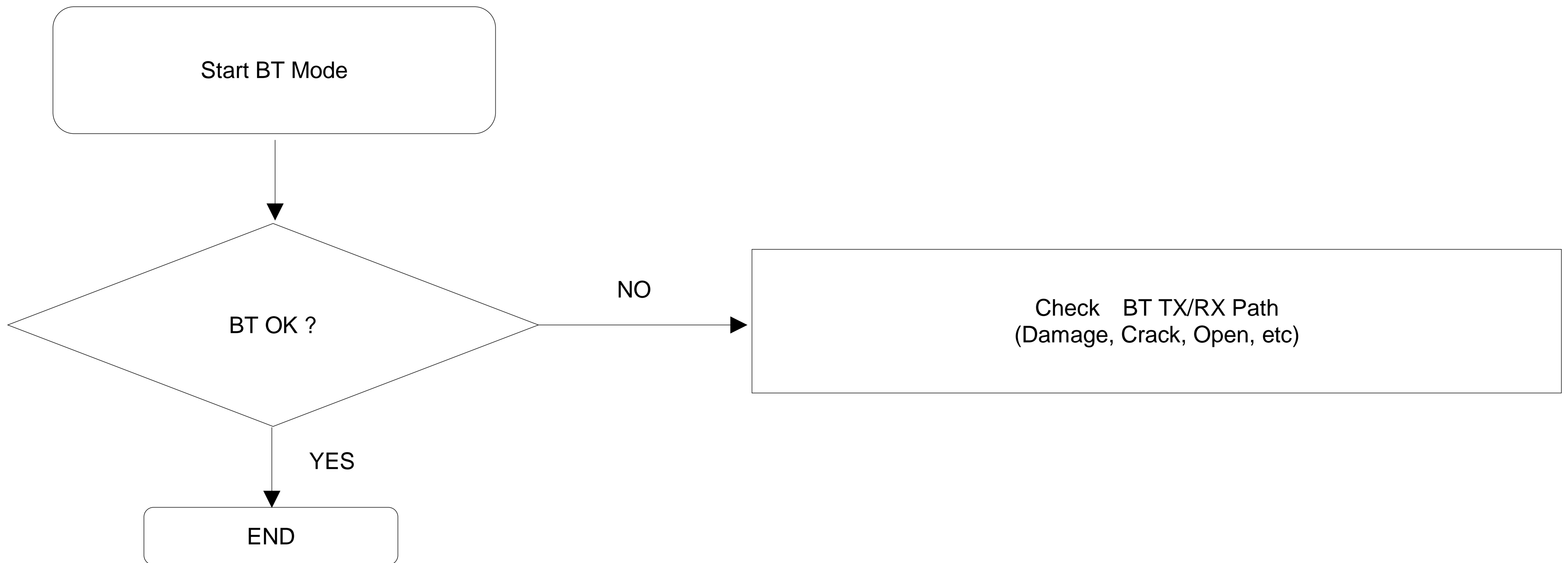

- GPS

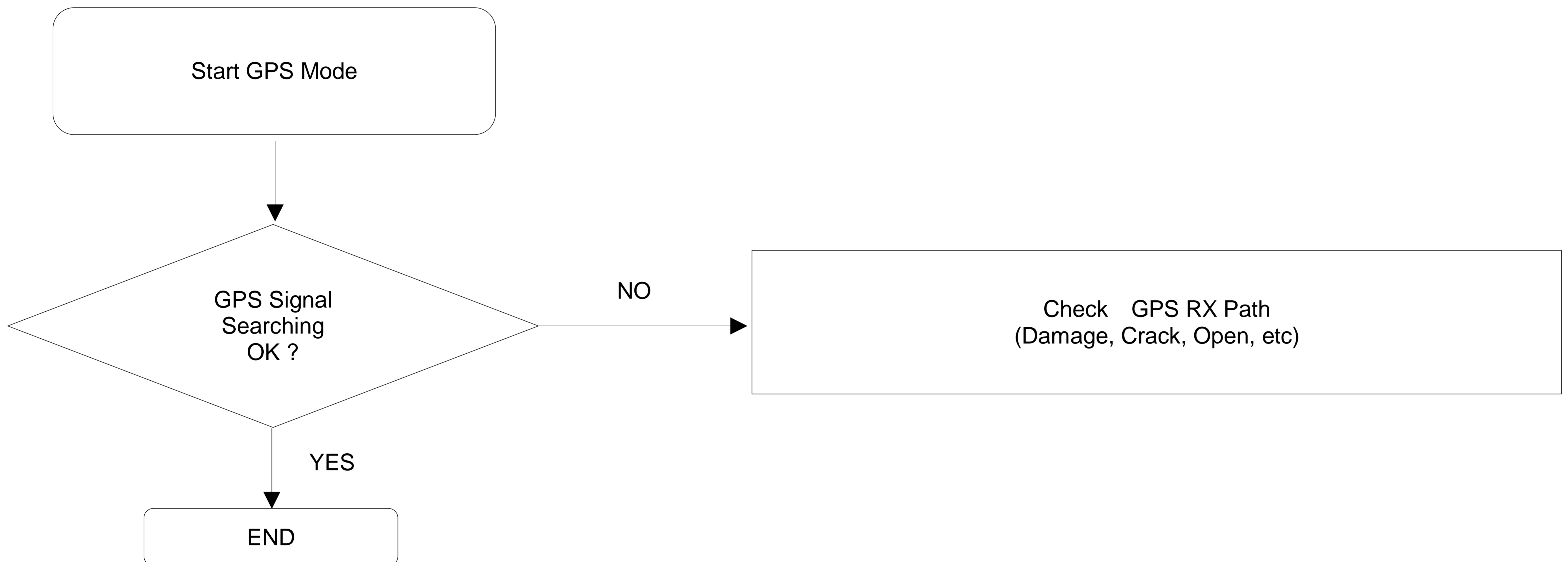

8. Level 3 Repair

8-3-14. FM RADIO

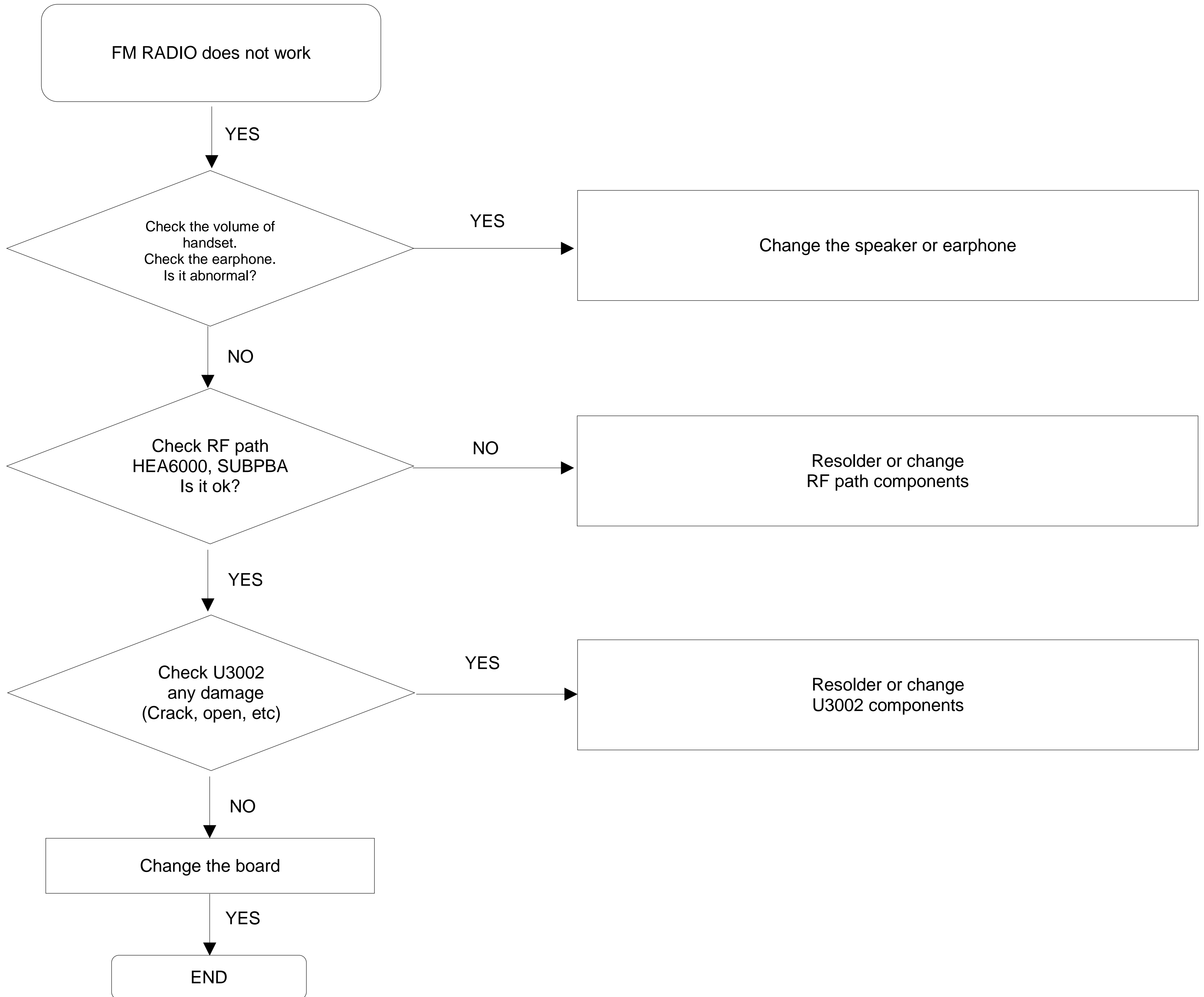

8. Level 3 Repair

8-3-15. NFC

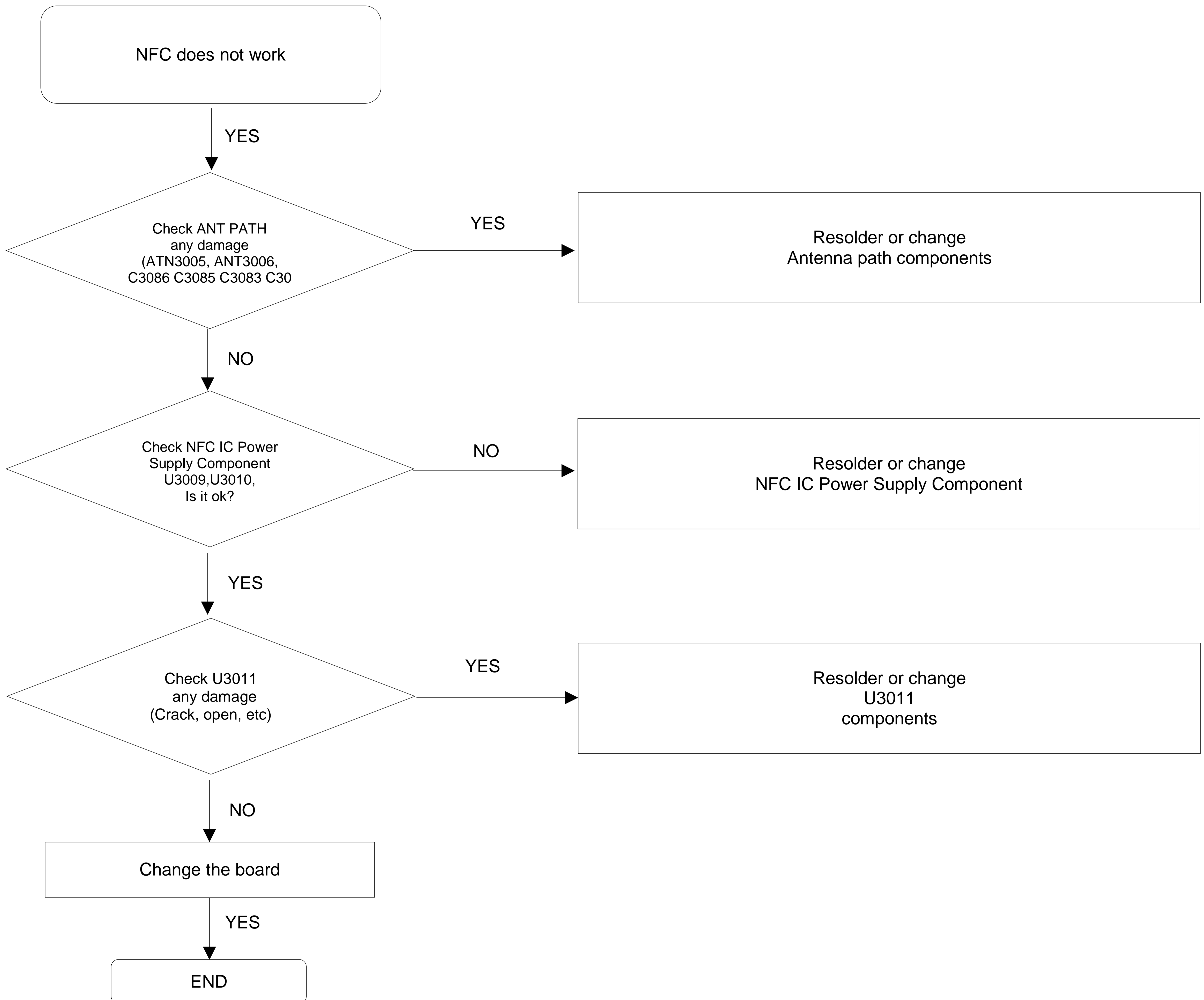

8. Level 3 Repair

8-4. Service Schematics

- NC Point(Top View)

UCP400(AP)

