

1. Safety Precautions

1-1. Repair Precaution

Before attempting any repair or detailed tuning, shield the device from RF noise or static electricity discharges.

Use only demagnetized tools that are specifically designed for small electronic repairs, as most electronic parts are sensitive to electromagnetic forces.

Use only high quality screwdrivers when servicing products. Low quality screwdrivers can easily damage the heads of screws.

Use only conductor wire of the properly gauge and insulation for low resistance, because of the low margin of error of most testing equipment.

We recommend 22-gauge twisted copper wire.

Hand-soldering is not recommended, because printed circuit boards (PCBs) can be easily damaged, even with relatively low heat. Never use a soldering iron with a power rating of more than 100 watts and use only lead-free solder with a melting point below 250°C (482°F).

Prior to disassembling the battery charger for repair, ensure that the AC power is disconnected.

Always use the replacement parts that are registered in the SEC system. Third-party replacement parts may not function properly.

1. Safety Precautions

1-2. ESD(Electrostatically Sensitive Devices) Precaution

Many semiconductors and ESDs in electronic devices are particularly sensitive to static discharge and can be easily damaged by it. We recommend protecting these components with conductive anti-static bags when you store or transport them.

Always use an anti-static strap or wristband and remove electrostatic buildup or dissipate static electricity from your body before repairing ESDs.

Ensure that soldering irons have AC adapter with ground wires and that the ground wires are properly connected.

Use only desoldering tools with plastic tips to prevent static discharge.

Properly shield the work environment from accidental electrostatic discharge before opening packages containing ESDs.

The potential for static electricity discharge may be increased in low humidity environments, such as air-conditioned rooms. Increase the airflow to the working area to decrease the chance of accidental static electricity discharges.

2. Specification

2-1. GSM General Specification

Item		GSM 850	EGSM 900	DCS1800	PCS1900
Freq. Band[MHz]		824~849	880~915	1710~1785	1850~1910
Uplink/Downlink		869~894	925~960	1805~1880	1930~1990
ARFCN range		128~251	0~124 & 975~1023	512~885	512~810
Tx/Rx spacing		45MHz	45MHz	95MHz	80MHz
Mod. Bit rate/ Bit Period		270.833kbps 3.692us	270.833kbps 3.692us	270.833kbps 3.692us	270.833kbps 3.692us
Time Slot Period/ Frame Period		576.9us 4.615ms	576.9us 4.615ms	576.9us 4.615ms	576.9us 4.615ms
Modulation	GSM/ EGPRS	GMSK/ 8PSK	GMSK/ 8PSK	GMSK/ 8PSK	GMSK/ 8PSK
MS Power		33dBm~5dBm	33dBm~5dBm	30dBm~0dBm	30dBm~0dBm
Power Class		4(GMSK) E2(8PSK)	4(GMSK) E2(8PSK)	1(GMSK) E2(8PSK)	1(GMSK) E2(8PSK)
Sensitivity		-102dBm	-102dBm	-100dBm	-100dBm
TDMA Mux		8	8	8	8

2. Specification

2-2. WCDMA General Specification

Item	WCDMA 2100(B1)	WCDMA 1900(B2)	WCDMA AWS(B4)	WCDMA 850(B5)	WCDMA 900(B8)
Freq. Band[MHz] Uplink/Downlink	1920~1980 2110~2170	1850~1910 1930~1990	1710~1755 2110~2155	824~849 869~894	880~915 925~960
ARFCN range	UL: 9612~9888 DL: 10562~10838	UL: 9262~9538 DL: 9662~9938	UL: 1312~1513 DL: 1537~1738	UL: 4132~4233 DL: 4357~4458	UL: 2712~2868 DL: 2937~3088
Tx/Rx spacing	190MHz	80MHz	400MHz	45MHz	45MHz
Mod. Bit rate/ Bit Period	42.2Mbps(DL) 5.42Mbps(UL)	42.2Mbps(DL) 5.42Mbps(UL)	42.2Mbps(DL) 5.42Mbps(UL)	42.2Mbps(DL) 5.42Mbps(UL)	42.2Mbps(DL) 5.42Mbps(UL)
Time Slot Period/ Frame Period	WCDMA 10ms/0.667ms HSPA 2ms/0.667ms	WCDMA 10ms/0.667ms HSPA 2ms/0.667ms	WCDMA 10ms/0.667ms HSPA 2ms/0.667ms	WCDMA 10ms/0.667ms HSPA 2ms/0.667ms	WCDMA 10ms/0.667ms HSPA 2ms/0.667ms
Modulation	QPSK 16QAM 64QAM	QPSK 16QAM 64QAM	QPSK 16QAM 64QAM	QPSK 16QAM 64QAM	QPSK 16QAM 64QAM
MS Power (dBm)	25.7 ~ -49(↓)	25.7 ~ -49(↓)	25.7 ~ -49(↓)	25.7 ~ -49(↓)	25.7 ~ -49(↓)
Power Class	3(max+24dBm)	3(max+24dBm)	3(max+24dBm)	3(max+24dBm)	3(max+24dBm)
Sensitivity	-106dBm	-104dBm	-106dBm	-104dBm	-103dBm

2. Specification

2-3. LTE General Specification

Item	LTE Band1	LTE Band2	LTE Band3	LTE Band4	LTE Band5	LTE Band7
Freq. Band[MHz]	1920~1980	1850~1910	1710~1785	1710~1755	824~849	2500~2570
Uplink/Downlink	2110~2170	1930~1990	1805~1880	2110~2155	869~894	2620~2690
ARFCN range	UL:18000~18599 DL:0~599	UL:18600~19199 DL:600~1199	UL:19200~19949 DL:1200~1949	UL:19950~20399 DL:1950~2399	UL:20400~20649 DL:2400~2649	UL:20750~21449 DL:2750~3449
Tx/Rx spacing (MHz)	190	80	95	400	45	120
Channel Bandwidth (MHz)	5/10/15/20	1.4/3/5/10/15/20	1.4/3/5/10/15/20	1.4/3/5/10/15/20	1.4/3/5/10	5/10/15/20
Modulation	QPSK, 16/64QAM 256QAM(DL only)	QPSK, 16/64QAM 256QAM(DL only)	QPSK, 16/64QAM 256QAM(DL only)	QPSK, 16/64QAM 256QAM(DL only)	QPSK, 16/64QAM 256QAM(DL only)	QPSK, 16/64QAM 256QAM(DL only)
MS Power (dBm)	25.7~-39(↓)	25.7~-39(↓)	25.7~-39(↓)	25.7~-39(↓)	25.7~-39(↓)	25.7~-39(↓)
Sensitivity (QPSK, BW 10MHz) (dBm)	-96.3	-94.3	-93.3	-96.3	-94.3	-94.3

Item	LTE Band8	LTE Band12	LTE Band13	LTE Band17	LTE Band18	LTE Band19
Freq. Band[MHz]	880~915	699~716	777~787	704~716	815~830	830~845
Uplink/Downlink	925~960	729~746	746~756	734~746	860~875	875~890
ARFCN range	UL:21450~21799 DL:3450~3799	UL:23010~23179 DL:5010~5179	UL:23180~23279 DL:5180~5279	UL:23730~23849 DL:5730~5849	UL:23850~23999 DL:5850~5999	UL:24000~24149 DL:6000~6149
Tx/Rx spacing (MHz)	45	30	-31	30	45	45
Channel Bandwidth (MHz)	1.4/3/5/10	1.4/3/5/10	1.4/3/5/10	5/10	5/10/15	5/10/15
Modulation	QPSK, 16/64QAM 256QAM(DL only)	QPSK, 16/64QAM 256QAM(DL only)	QPSK, 16/64QAM 256QAM(DL only)	QPSK, 16/64QAM 256QAM(DL only)	QPSK, 16/64QAM 256QAM(DL only)	QPSK, 16/64QAM 256QAM(DL only)
MS Power (dBm)	25.7~-39(↓)	25.7~-39(↓)	25.7~-39(↓)	25.7~-39(↓)	25.7~-39(↓)	25.7~-39(↓)
Sensitivity (QPSK, BW 10MHz) (dBm)	-93.3	-93.3	-93.3	-93.3	-96.3	-96.3

2. Specification

Item	LTE Band20	LTE Band25	LTE Band26	LTE Band28	LTE Band32	LTE Band38
Freq. Band[MHz] Uplink/Downlink	832~862 791~821	1850~1915 1930~1995	814~849 859~894	703~748 758~803	N/A 1452~1496	2570~2620
ARFCN range	UL:24150~24449 DL:6150~6449	UL:26040~26689 DL:8040~8689	UL:26690~27039 DL:8690~9039	UL:27210~27659 DL:9210~9659	DL:9920~10359	UL/DL:37750 ~ 38249
Tx/Rx spacing (MHz)	-41	80	45	55	N/A	0
Channel Bandwidth (MHz)	5/10/15/20	1.4/3/5/10/15/20	1.4/3/5/10/15	3/5/10/15/20	5/10/15/20	5/10/15/20
Modulation	QPSK,16/64QAM 256QAM(DL only)	QPSK,16/64QAM 256QAM(DL only)	QPSK,16/64QAM 256QAM(DL only)	QPSK,16/64QAM 256QAM(DL only)	QPSK,16/64QAM 256QAM(DL only)	QPSK,16/64QAM 256QAM(DL only)
MS Power (dBm)	25.7~-39(↓)	25.7~-39(↓)	25.7~-39(↓)	25.7~-39(↓)	25.7~-39(↓)	25.7~-39(↓)
Sensitivity (QPSK, BW 10MHz) (dBm))	-93.3	-92.8	-93.8	-94.8	-96.3	-96.3

Item	LTE Band39	LTE Band40	LTE Band41	LTE Band66
Freq. Band[MHz] Uplink/Downlink	1880~1920	2300~2400	2496~2690	1710~1780 2110~2200
ARFCN range	UL/DL:38250 ~ 38649	UL/DL:38650 ~ 39649	UL/DL:39650 ~ 41589	UL:131972~132671 DL:66436~67335
Tx/Rx spacing (MHz)	0	0	0	400
Channel Bandwidth (MHz)	5/10/15/20	5/10/15/20	5/10/15/20	1.4/3/5/10/15/20
Modulation	QPSK,16/64QAM 256QAM(DL only)	QPSK,16/64QAM 256QAM(DL only)	QPSK,16/64QAM 256QAM(DL only)	QPSK,16/64QAM 256QAM(DL only)
MS Power (dBm)	25.7~-39(↓)	25.7~-39(↓)	25.7~-39(↓)	25.7~-39(↓)
Sensitivity (QPSK, BW 10MHz) (dBm)	-96.3	-96.3	-94.3	-95.8

2. Specification

2-4. TDSCDMA General Specification

Item	TDSCDMA2010(A)	TDSCDMA1880(F)
Chip rate	1.28 Mcps	1.28 Mcps
OBW	1.6 MHz	1.6 MHz
Freq. Band[MHz] Uplink/Downlink	2010~2025	1880~1920
ARFCN range	10054~10121	9404~9596
Tx/Rx spacing (MHz)	0	0
MS Power (dBm)	25.7 ~ -48(↓)	25.7 ~ -48(↓)
Power Class	2(max+24dBm)	2(max+24dBm)
Sensitivity (dBm /1.28 MHz)	-107.3	-107.3

2. Specification

2-5. GSM Tx Power Class

TX Power Control level	GSM850	TX Power Control level	EGSM900	TX Power Control level	DCS1800	TX Power Control level	PCS1900
5	33±2 dBm	5	33±2 dBm	0	30±3 dBm	0	30±3 dBm
6	31±2 dBm	6	31±2 dBm	1	28±3 dBm	1	28±3 dBm
7	29±2 dBm	7	29±2 dBm	2	26±3 dBm	2	26±3 dBm
8	27±2 dBm	8	27±2 dBm	3	24±3 dBm	3	24±3 dBm
9	25±2 dBm	9	25±2 dBm	4	22±3 dBm	4	22±3 dBm
10	23±2 dBm	10	23±2 dBm	5	20±3 dBm	5	20±3 dBm
11	21±2 dBm	11	21±2 dBm	6	18±3 dBm	6	18±3 dBm
12	19±2 dBm	12	19±2 dBm	7	16±3 dBm	7	16±3 dBm
13	17±2 dBm	13	17±2 dBm	8	14±3 dBm	8	14±3 dBm
14	15±2 dBm	14	15±2 dBm	9	12±4 dBm	9	12±4 dBm
15	13±2 dBm	15	13±2 dBm	10	10±4 dBm	10	10±4 dBm
16	11±3 dBm	16	11±3 dBm	11	8±4 dBm	11	8±4 dBm
17	9±3dBm	17	9±3dBm	12	6±4 dBm	12	6±4 dBm
18	7±3 dBm	18	7±3 dBm	13	4±4 dBm	13	4±4 dBm
19	5±3 dBm	19	5±3 dBm	14	2±5 dBm	14	2±5 dBm
-	-	-	-	15	0±5 dBm	15	0±5 dBm

3. Product Function

Main Function

Item	Description
OS	Android V8.0
SM-A750FN/F RF	GSM850 / GSM900 / DCS1800 / PCS1900 WCDMA: B1/ B2/ B5/ B8 LTE: B1/ B2/ B3/ B5/ B7/ B8/ B12/ B13/ B17 B20 / B28/ B38/ B40/ B41/ B66
SM-A750GN/G RF	GSM850 / GSM900 / DCS1800 / PCS1900 WCDMA: B1/ B2/ B4/ B5/ B8 LTE: B1/ B2/ B3/ B4/ B5/ B7/ B8/ B12/ B13/ B17 B20 / B28/ B38/ B40/ B41/ B66
Battery	3300mAh
Base Band	2.2Ghz Quad + 1.6GHz Quad
Other RF	A-GPS, Glonass, BT5.0, USB 2.0, WIFI 802.11 a/b/g/n/ac, NFC
Camera	Triple Camera (Main : 24M Dual A/F, OIS, F1.7 & Depth : 5M, F2.2 & Wide angle 8M, F2.4) with LED Flash, 24MP (Front) with LED Flash,
LCD	6.0", FHD+, 2220x1080
SM-A750FN /G RAM+ROM	4GB+64GB / 4GB+128GB
SM-A750F/GN RAM+ROM	4GB+64GB / 4GB+128GB / 6GB+128GB
Sensor	Accelerometer, Fingerprint Sensor, Gyro Sensor, Hall Sensor, Proximity Sensor, RGB Light Sensor, Magnetic sensor, Grip sensor
Accessory	Charger: 5V/ 1.55A Data cable: 3.0pi, 0.8m(Type B/ USB-A) Ear phone: 3.5pi, 5pin

6. Level 1 Repair

6-1. S/W Update

6-1-1. Preparation

- S/W Update program : [Fenrir 5.17.xxxx](#)
- Mobile Phone
- Data Cable

※ Settings

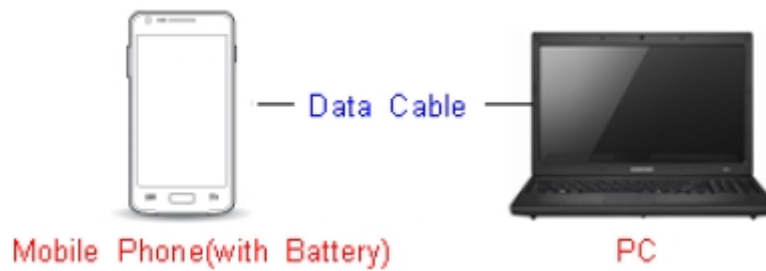

Data Cable : [GH39-01710D](#)

6. Level 1 Repair

6-1-2. How to use 'Fenrir' S/W update program.

1) Launch Fenrir by clicking on the icon on the desktop



- SVH (Fenrir_Home) : It uses Home binary which does not have user data area in the memory when flashed to a device. (Keep user data)

- SVC (Fenrir_Factory) : It uses Factory binary which erases all user data in the memory when flashed to a device. (Clear user data)

- SVA (Fenrir_All) : It uses Factory and Home binaries. you can download Home and Factory binary in a PC (but requires double HDD storage and NW traffic)

2) Input ID & password

※ You need to reset the ID information in case of PC change and format and repair, hard disk change

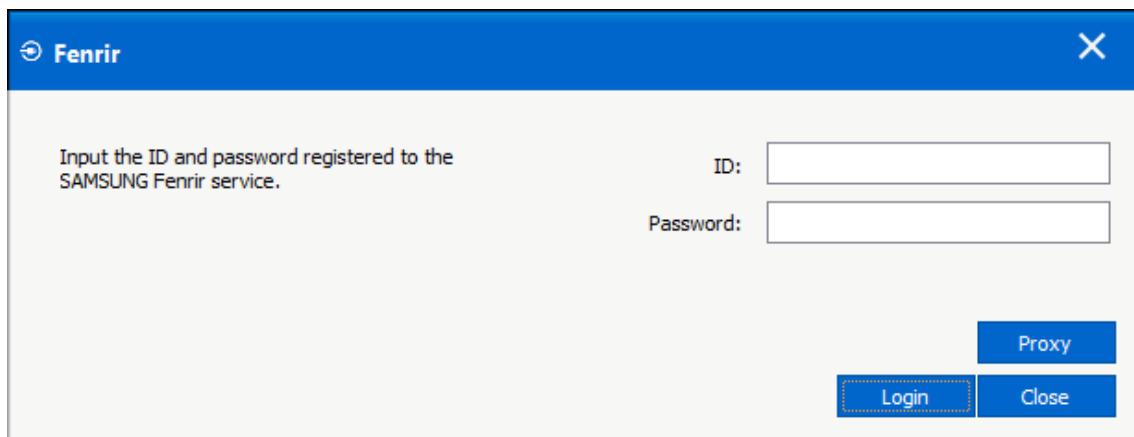
A screenshot of the Fenrir software login window. The window has a blue title bar with the text 'Fenrir' and a close button. The main area is white and contains the text 'Input the ID and password registered to the SAMSUNG Fenrir service.' followed by two input fields: 'ID:' and 'Password:'. Below the input fields are three buttons: 'Proxy', 'Login', and 'Close'. The 'Login' button is highlighted with a dashed border.

6. Level 1 Repair

3) Ensure device has sufficient charge (at least 20%) to start firmware update.

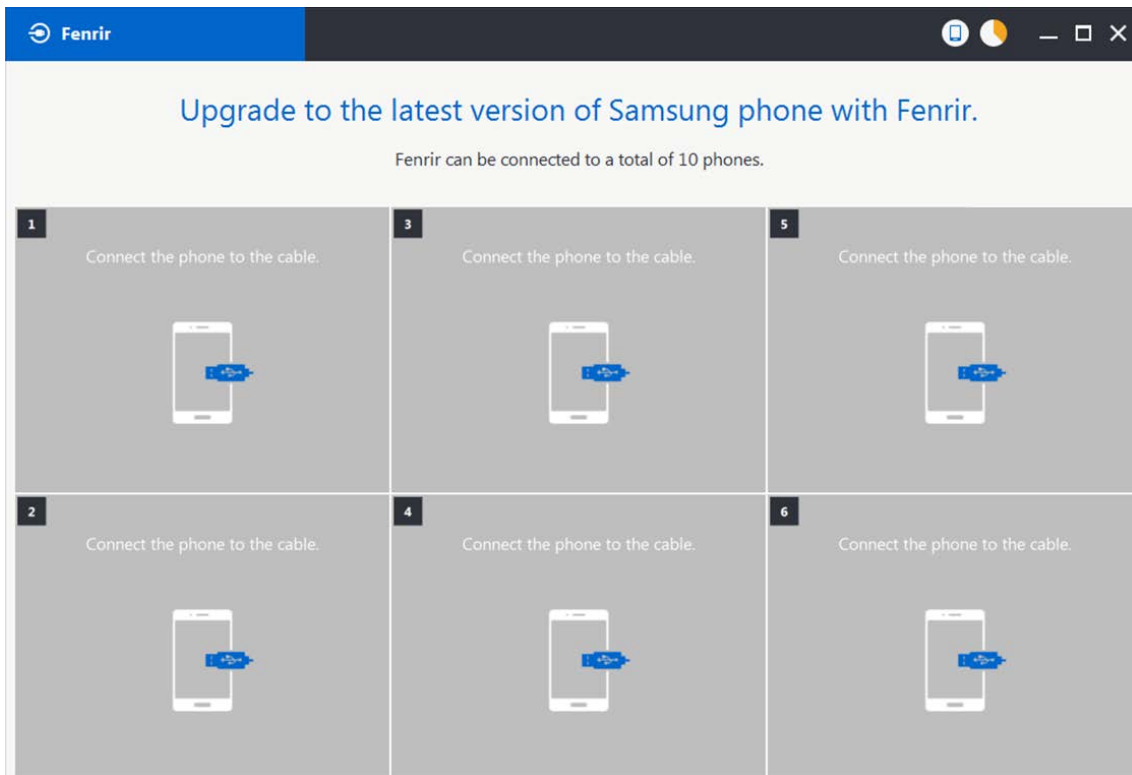

4) Connect the device to PC via data cable.

5) Upon USB connection, you will be presented with below screen.

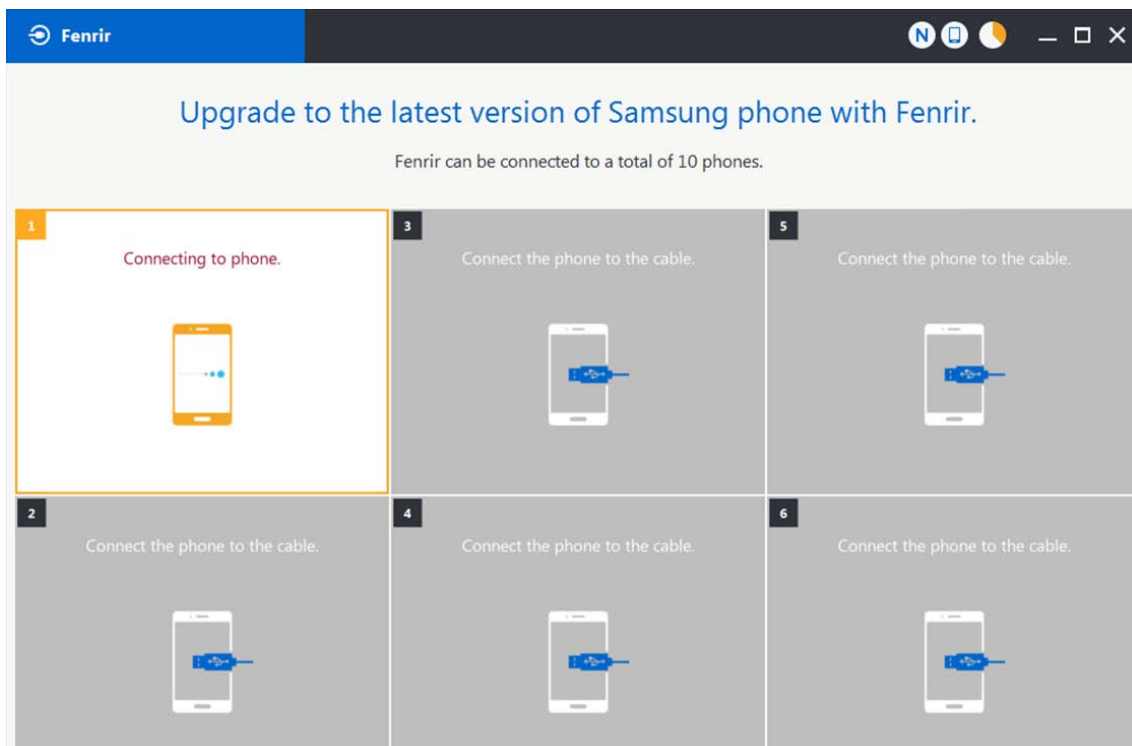

6. Level 1 Repair

6) Once device is detected, you will be presented with below screen. To update S/W, select “S/W Update” or to exit select “SVC Connection”. If you select “SVC Connection”, only Fenrir connection history (record) will be stored in the FUS server to support warranty validation. (This is known as “Service Connection” history)

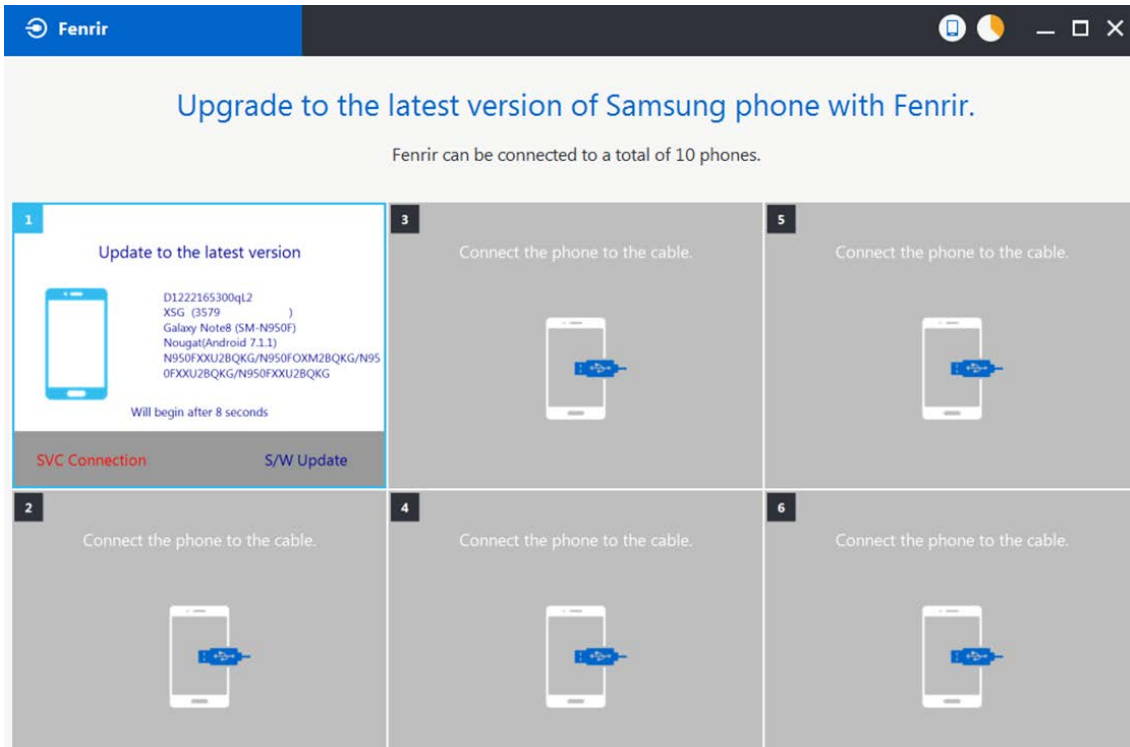

7) Once Fenrir starts, application will display the below screen. And select the Start button & Agree button.

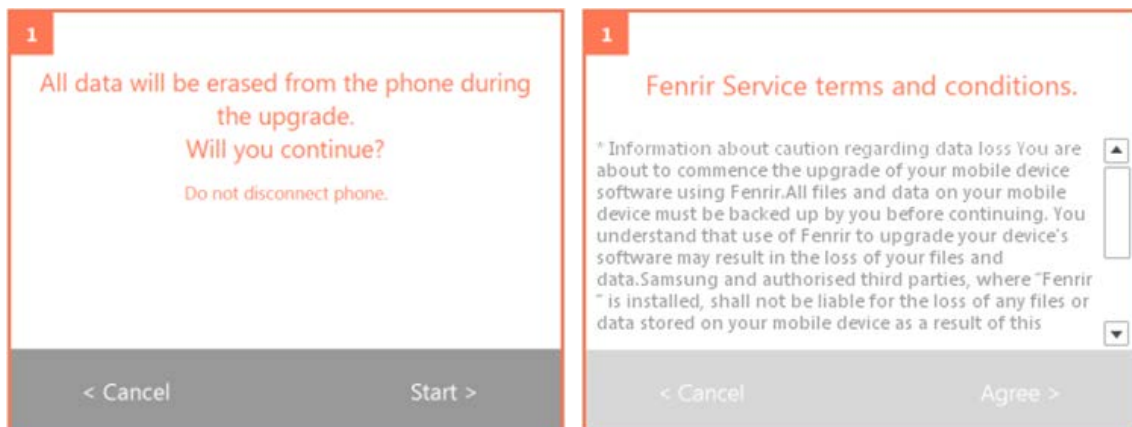

6. Level 1 Repair

8) The status circle increases as the update installs. The update process takes approximately 5-10 minutes to complete. Do not disconnect the device from USB during processing.

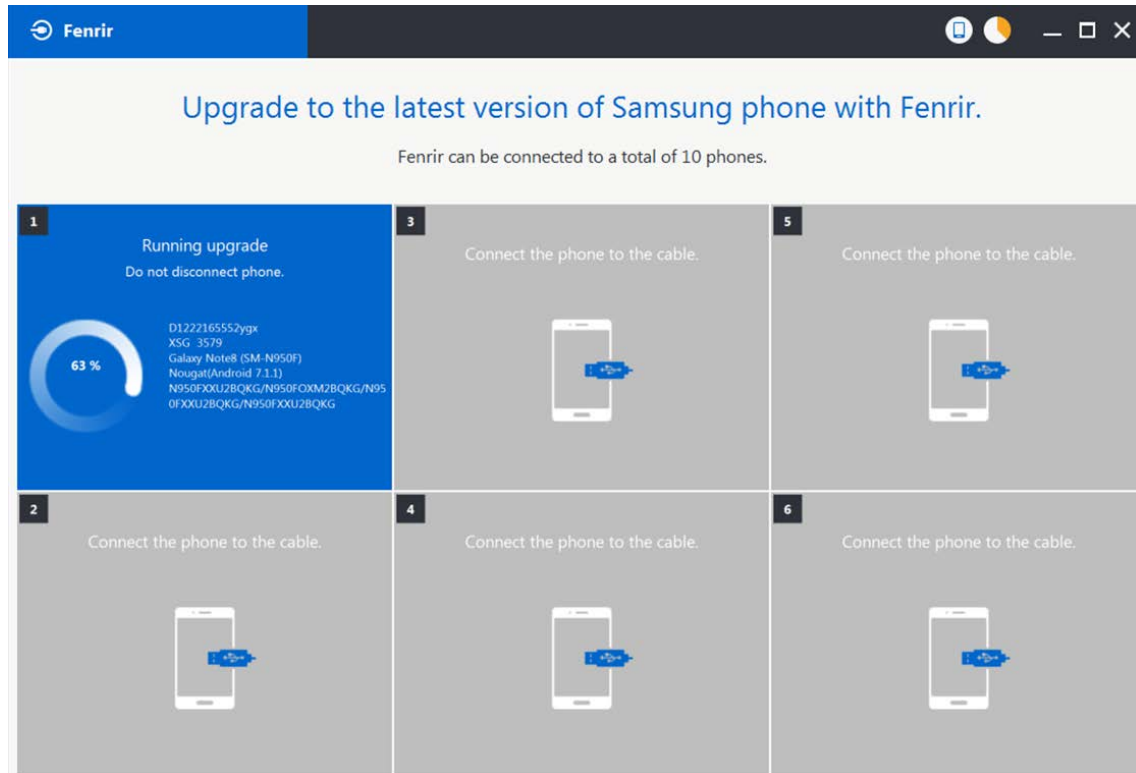

9) Once complete, application will present the below screen indicating update complete. Click Ok and detach device from USB.

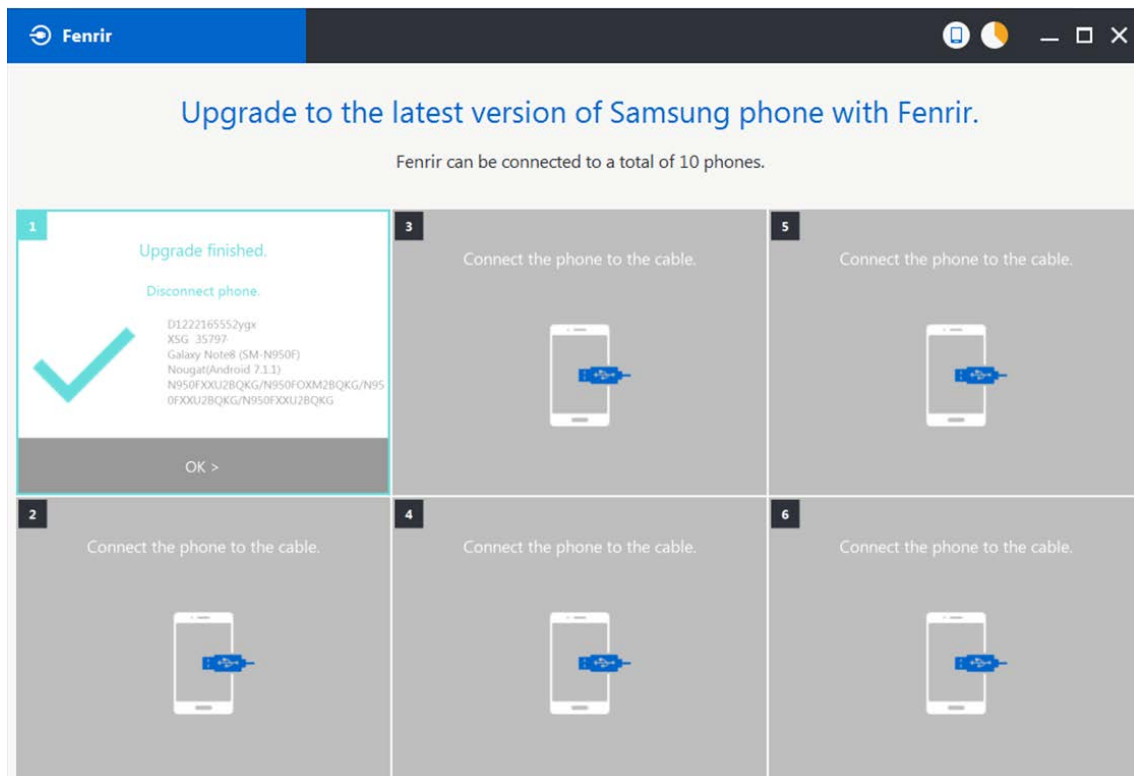

6. Level 1 Repair

6-2. How to use 'Odin' program

※ S/W Update via Fenrir is mandatory.

Below is the method to use 'Odin' program in any specific case.

6-2-1. Preparation

- Installation program : [Odin3 v3.13.2.exe or above](#)
- Mobile Phone
- Data Cable
- S/W Binary files (downloaded from GSPN)

※ Settings

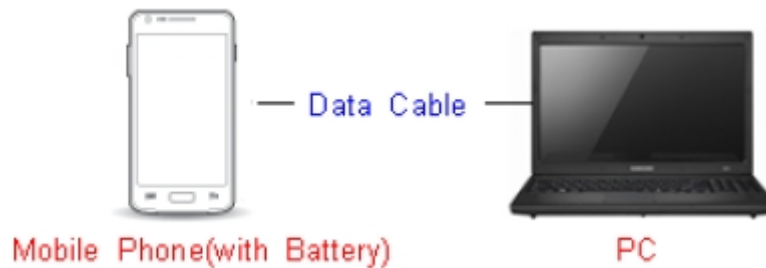

Data Cable : [GH39-01710D](#)

6. Level 1 Repair

6-2-2. S/W Installation Program (Downloader program)

Open up the S/W Installation Program by executing the "**Odin3 v3.13.2.exe**"

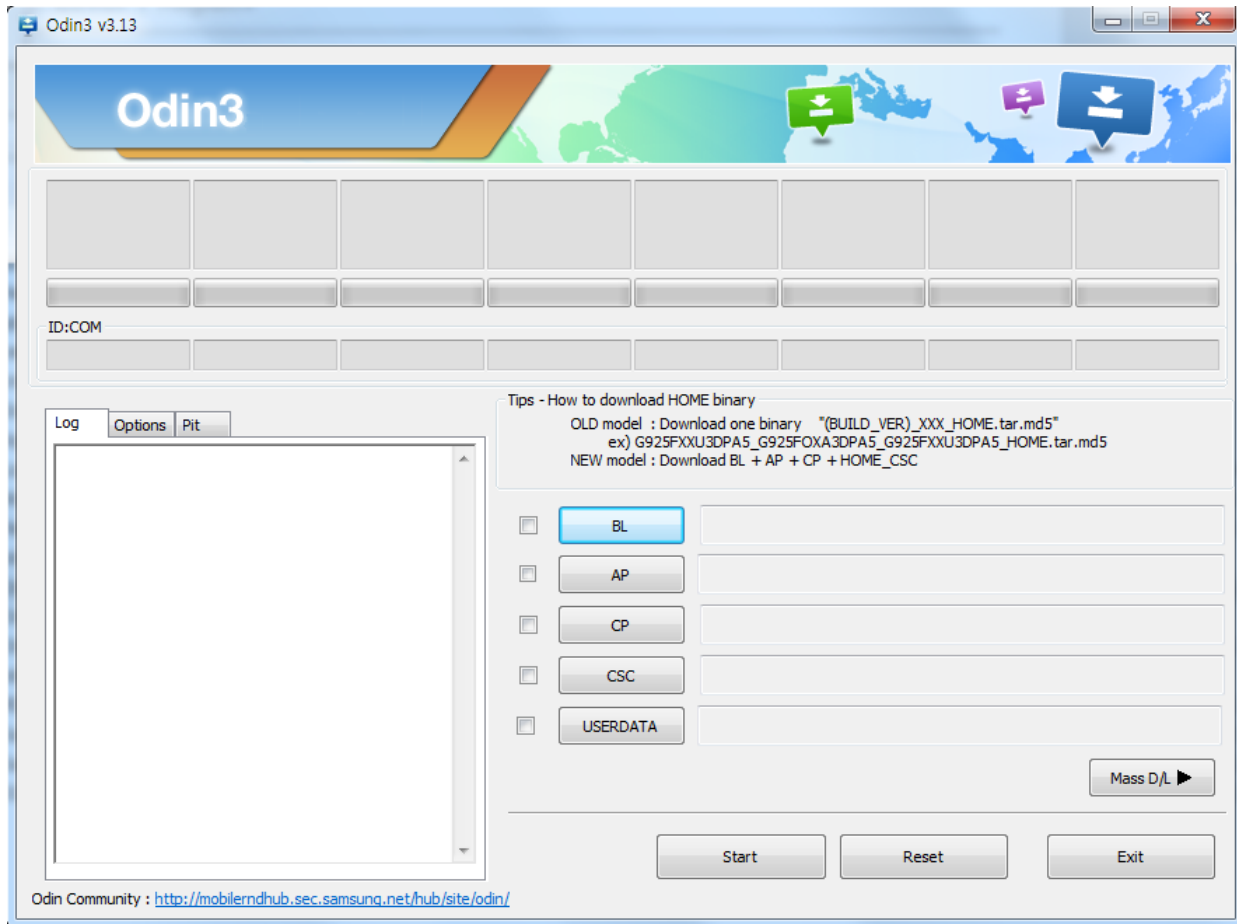

6. Level 1 Repair

1. Enable the check mark by click on the following options

- Check Auto Reboot, F. Reset Time, Nand Erase
- Check BL, AP, CP, CSC Files

* Note : "Odin v3.13.2 or above" checks MD5 checksum just after file selection.

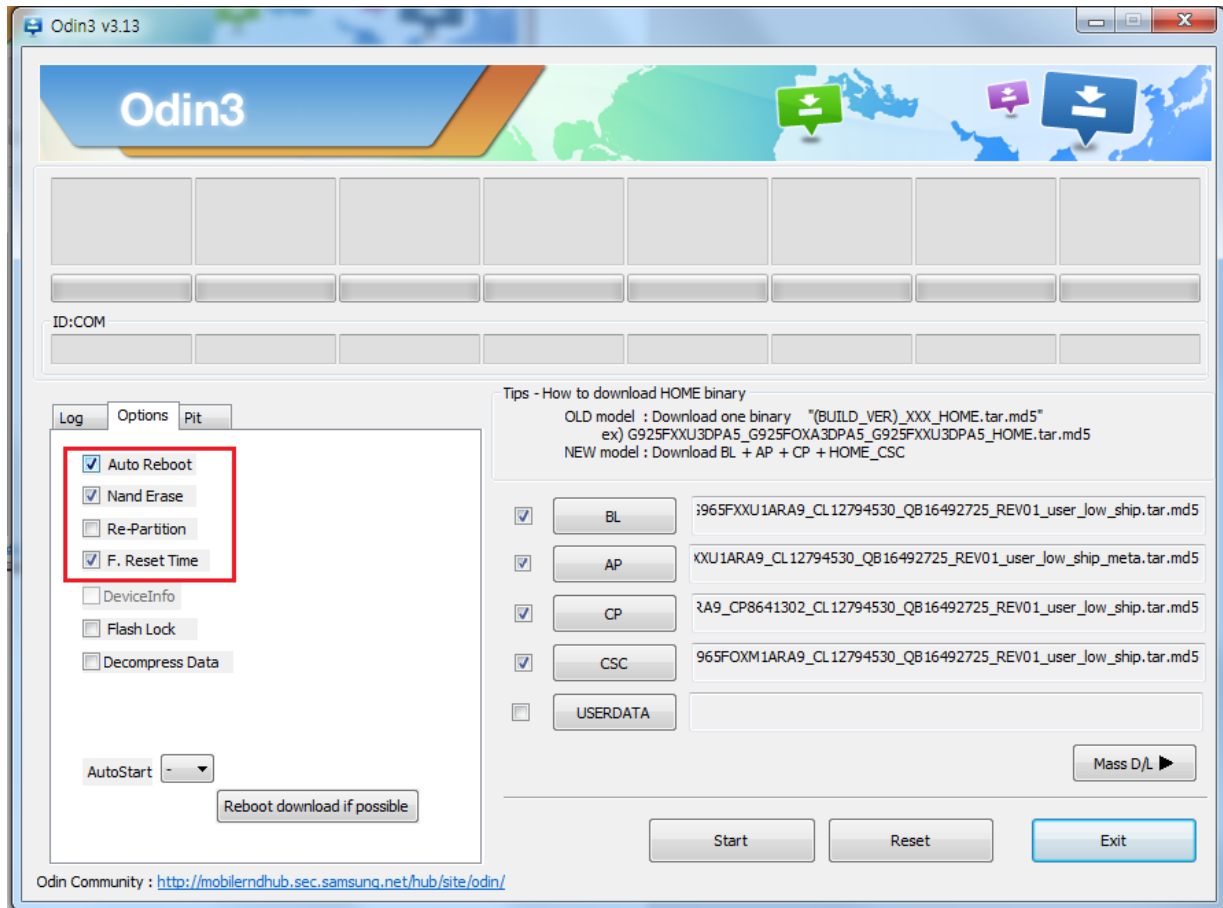

6. Level 1 Repair

2. Enter into Download Mode

- Enter into Download Mode by pressing Volume Down button, Intelligence button and ON/OFF Button simultaneously followed by pressing Volume up button as a direction of the phone.



Volume UP+DOWN

6. Level 1 Repair

3. Connect the device to PC via Data Cable.

Make sure that the one of communication ports [ID:COM] box is highlighted in sky blue. The device is now connected with the PC and ready to download the binary files in it.

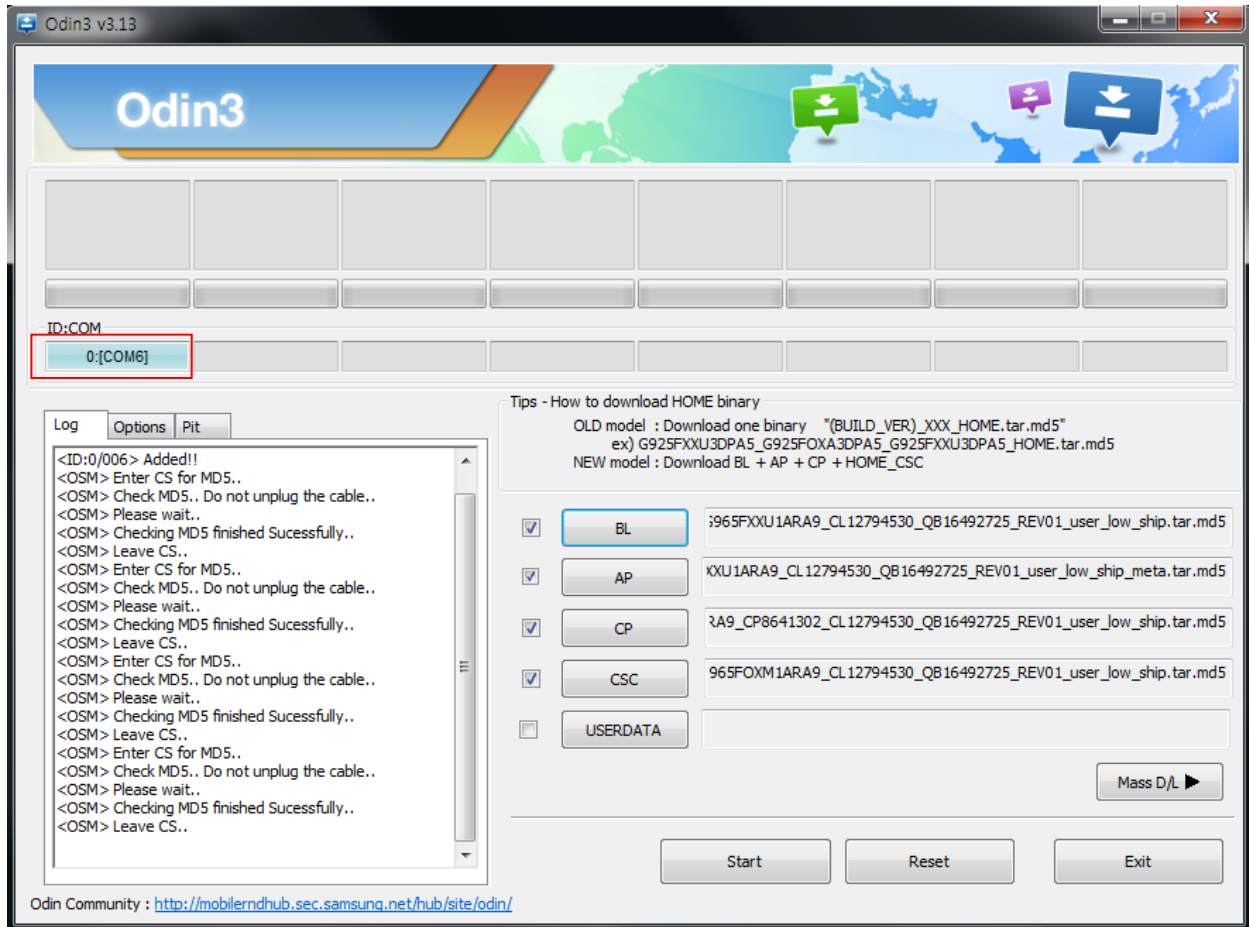

6. Level 1 Repair

4. Start downloading the binary files into the device by clicking Start button on the screen.

The green colored "PASS!" sign will appear on the upper-left box if the binary files have been successfully downloaded into the device.

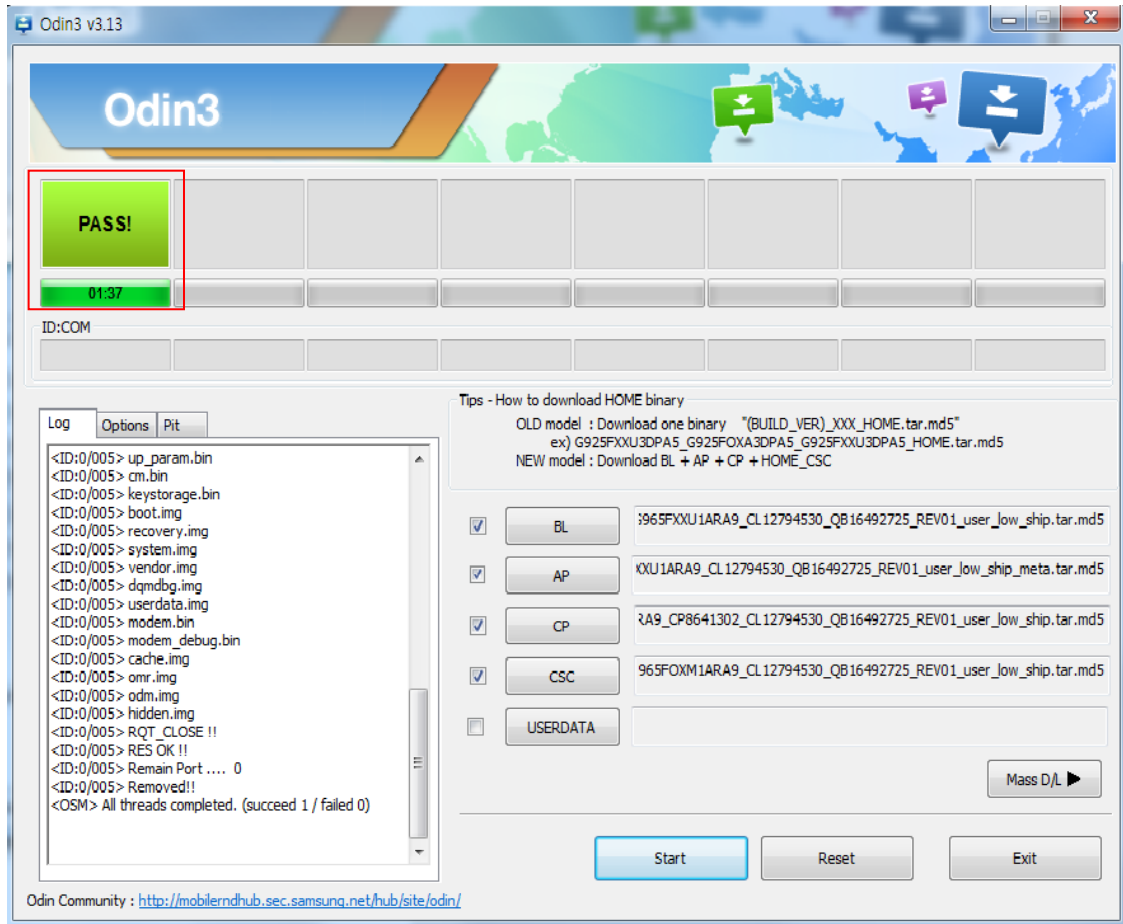

5. Disconnect the device from the Data cable.

6. Once the device boots up, you can check the version of the binary file or name by pressing the following code in sequence; ***#1234#**

You can perform Factory data Reset by Settings → General Management → Reset

※ Caution. Never disconnect during the S/W downloading.

6. Level 1 Repair

6-3. IMEI writing

6-3-1. Preparation

- New IMEI writing Program has been released.
- Supported Model : Models which CAB files are uploaded on HHPsvc INI File category, instead of ini file.
- Refer to below IMEI writing procedure.

- H/W

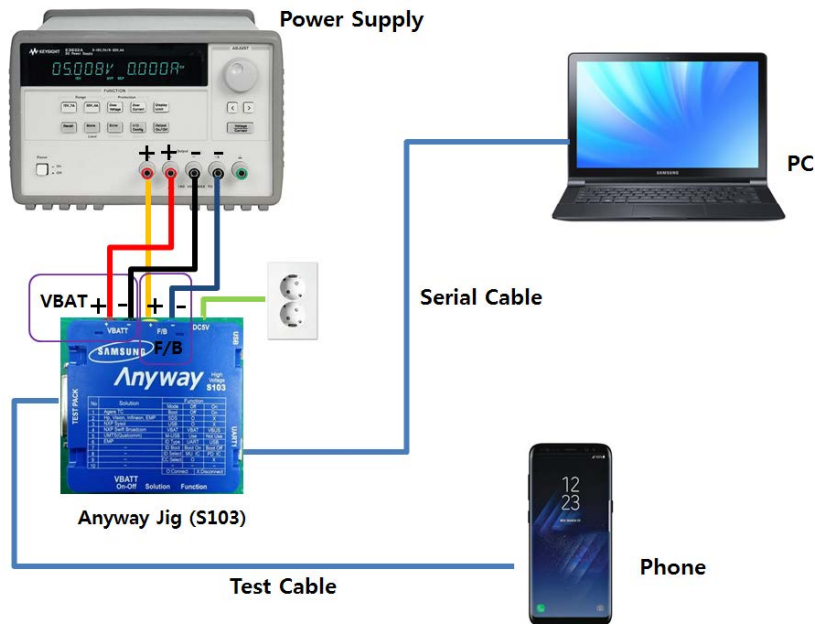

- S/W

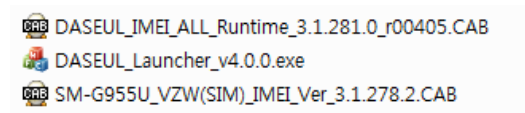
① Library Install	To use Daseul, library files should be installed. Refer to SVC Bulletin “(11-82) Daseul (New IMEI writing Program) Library Install guide_rev1.0”
② Launcher	DASEUL_SVC_Launcher_v3.0.12 or higher -Uploaded on HHPsvc Notice
③ Runtime File	1. DASEUL_IMEI_ALL_Runtime_3.1.281.0_r00405.CAB or higher -Uploaded on HHPsvc Notice 2. Make 'ModelName' folder at the same position with launcher & Runtime file. 
④ Model File	Copy Model File under the 'Model Name' folder

6. Level 1 Repair

6-3-2. IMEI writing Process

1. Run DASEUL_SVC_Launcher_v3.0.12.exe

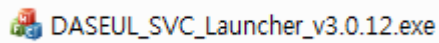

DASEUL_SVC_Launcher_v3.0.12.exe

2. Select Service Mode

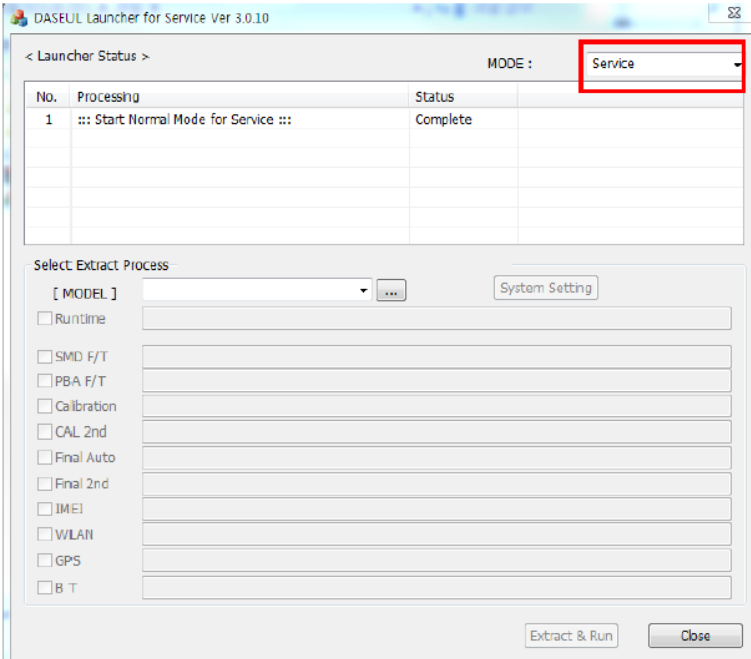

3. Click  and Select folder where the Launcher exists

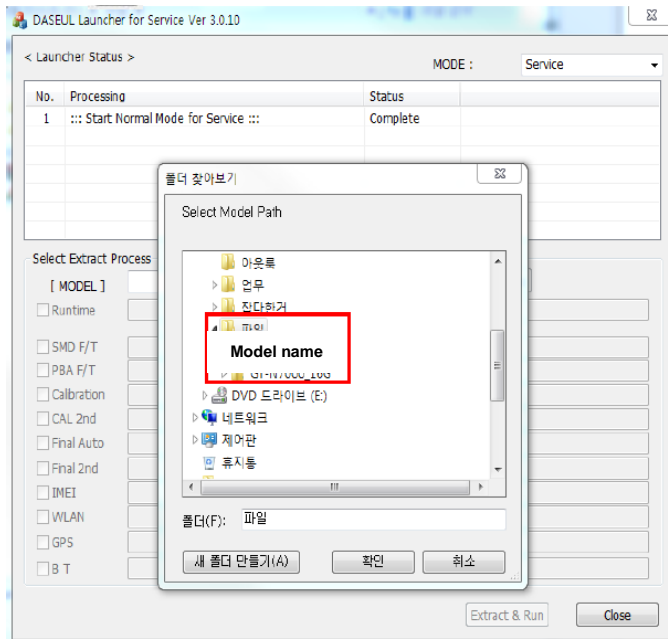

6. Level 1 Repair

4. Select Model

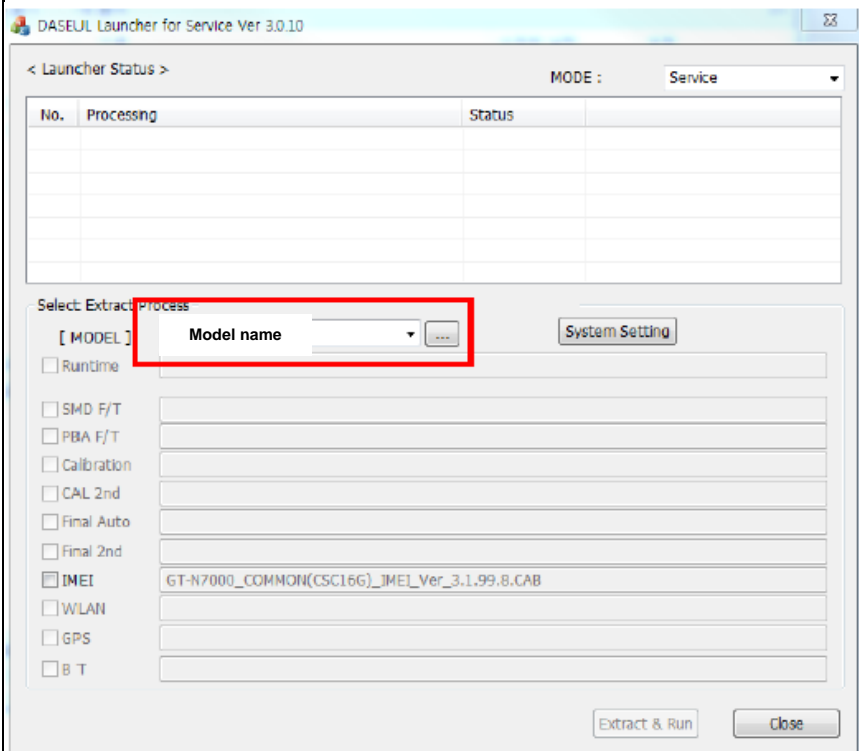

5. Check IMEI and click System Setting

※ Once you setup the setting, you don't have to do it again, unless there is change.
From second run of the IMEI program, check IMEI and click Extract & Run.

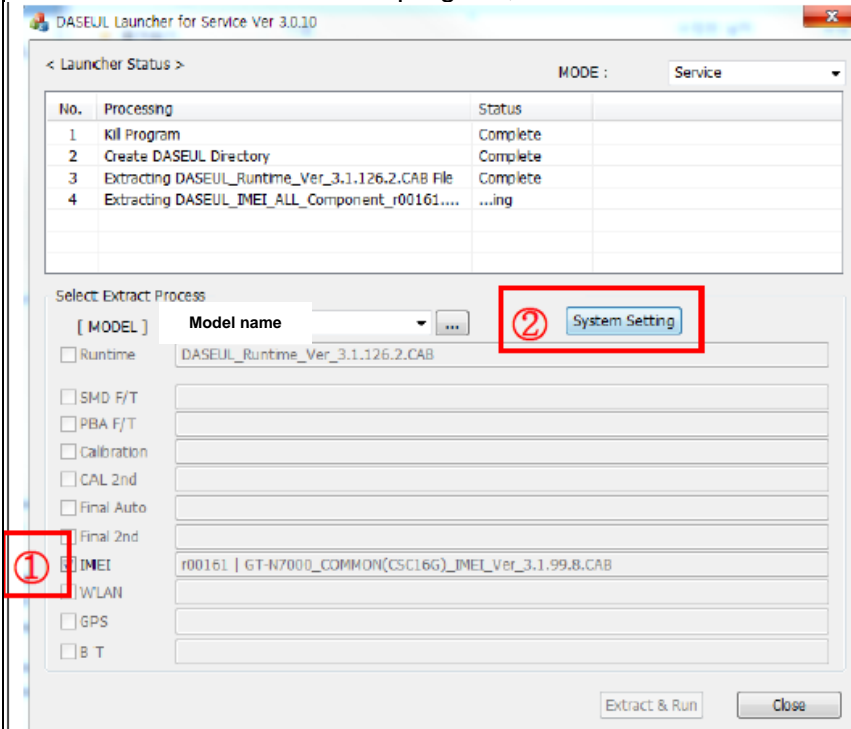

6. Level 1 Repair

6. Check IMEI Write / IMEI Check and click IMEI SVC & Repair Option.

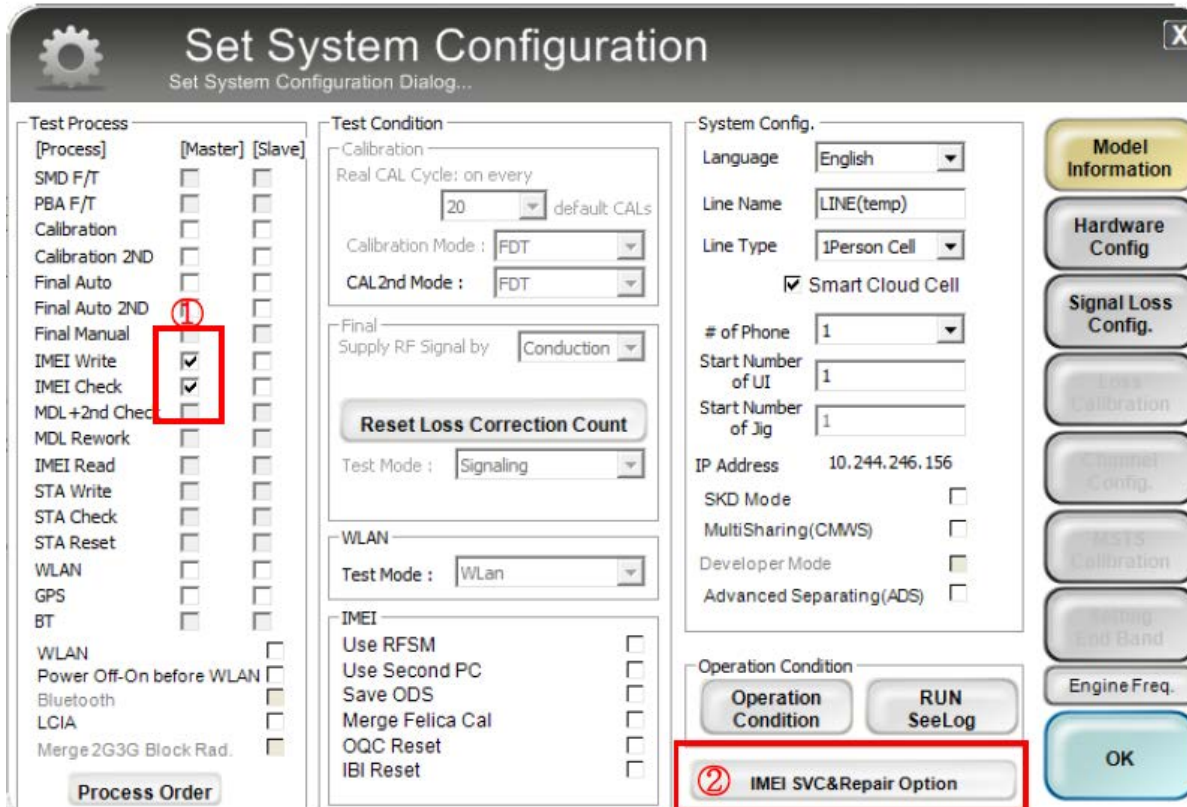

Set System Configuration
Set System Configuration Dialog...

Test Process

[Process]	[Master]	[Slave]
SMD F/T	<input type="checkbox"/>	<input type="checkbox"/>
PBA F/T	<input type="checkbox"/>	<input type="checkbox"/>
Calibration	<input type="checkbox"/>	<input type="checkbox"/>
Calibration 2ND	<input type="checkbox"/>	<input type="checkbox"/>
Final Auto	<input type="checkbox"/>	<input type="checkbox"/>
Final Auto 2ND	<input type="checkbox"/>	<input type="checkbox"/>
Final Manual	<input type="checkbox"/>	<input type="checkbox"/>
IMEI Write	<input checked="" type="checkbox"/>	<input type="checkbox"/>
IMEI Check	<input checked="" type="checkbox"/>	<input type="checkbox"/>
MDL+2nd Check	<input type="checkbox"/>	<input type="checkbox"/>
MDL Rework	<input type="checkbox"/>	<input type="checkbox"/>
IMEI Read	<input type="checkbox"/>	<input type="checkbox"/>
STA Write	<input type="checkbox"/>	<input type="checkbox"/>
STA Check	<input type="checkbox"/>	<input type="checkbox"/>
STA Reset	<input type="checkbox"/>	<input type="checkbox"/>
WLAN	<input type="checkbox"/>	<input type="checkbox"/>
GPS	<input type="checkbox"/>	<input type="checkbox"/>
BT	<input type="checkbox"/>	<input type="checkbox"/>
WLAN	<input type="checkbox"/>	<input type="checkbox"/>
Power Off-On before WLAN	<input type="checkbox"/>	<input type="checkbox"/>
Bluetooth	<input type="checkbox"/>	<input type="checkbox"/>
LCIA	<input type="checkbox"/>	<input type="checkbox"/>
Merge 2G3G Block Rad.	<input type="checkbox"/>	<input type="checkbox"/>

Test Condition

Calibration
Real CAL Cycle: on every 20 default CALs
Calibration Mode: FDT
CAL2nd Mode: FDT

Final
Supply RF Signal by: Conduction

Reset Loss Correction Count

Test Mode: Signaling

WLAN
Test Mode: WLAN

IMEI

Use RFSM	<input type="checkbox"/>
Use Second PC	<input type="checkbox"/>
Save ODS	<input type="checkbox"/>
Merge Felica Cal	<input type="checkbox"/>
OQC Reset	<input type="checkbox"/>
IBI Reset	<input type="checkbox"/>

System Config.

Language: English
Line Name: LINE(temp)
Line Type: 1Person Cell
 Smart Cloud Cell
of Phone: 1
Start Number of UI: 1
Start Number of Jig: 1
IP Address: 10.244.246.156
SKD Mode:
MultiSharing(CMWS):
Developer Mode:
Advanced Separating(ADS):

Operation Condition

Operation Condition:

IMEI SVC&Repair Option

Model Information
Hardware Config
Signal Loss Config.
Loss Calibration
Signal Config.
MMS Calibration
Setting End Band
Engine Freq.

7. Check 'SVC , User Ticket No' and click OK

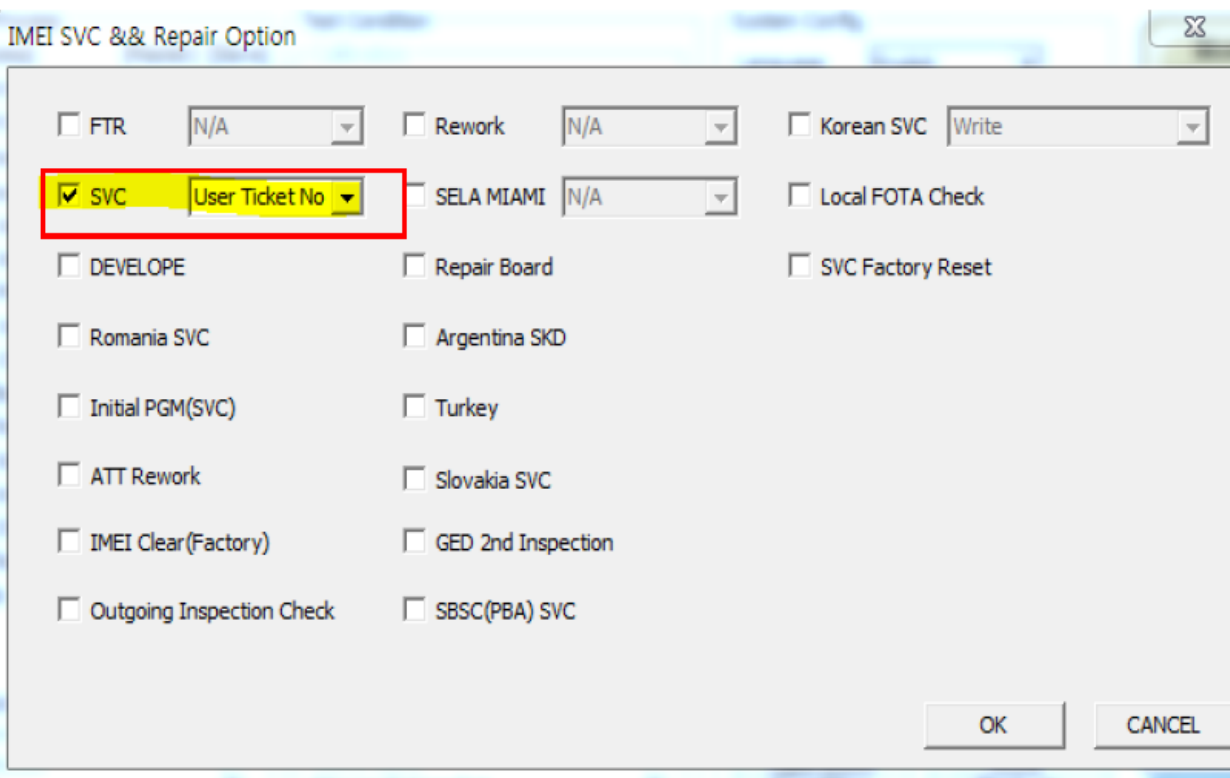

IMEI SVC && Repair Option

FTR N/A Rework N/A Korean SVC Write

SVC User Ticket No SELA MIAMI N/A Local FOTA Check

DEVELOPE Repair Board SVC Factory Reset

Romania SVC Argentina SKD

Initial PGM(SVC) Turkey

ATT Rework Slovakia SVC

IMEI Clear(Factory) GED 2nd Inspection

Outgoing Inspection Check SBSC(PBA) SVC

6. Level 1 Repair

8. Click 'Hardware Config'

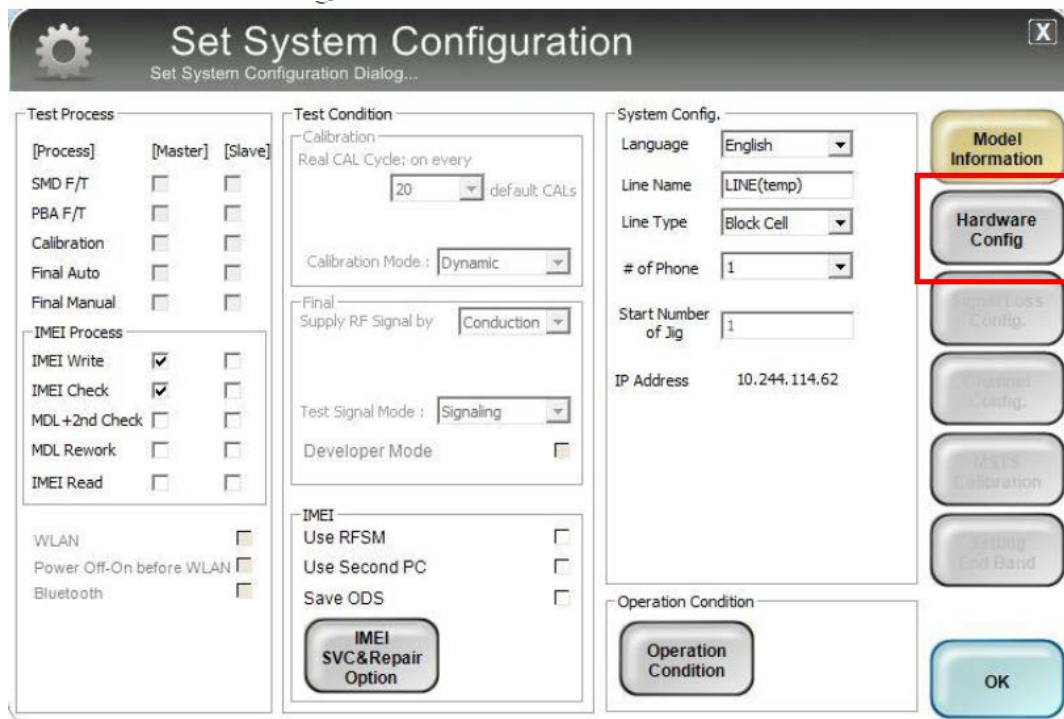

Set System Configuration
Set System Configuration Dialog...

Test Process

[Process]	[Master]	[Slave]
SMD F/T	<input type="checkbox"/>	<input type="checkbox"/>
PBA F/T	<input type="checkbox"/>	<input type="checkbox"/>
Calibration	<input type="checkbox"/>	<input type="checkbox"/>
Final Auto	<input type="checkbox"/>	<input type="checkbox"/>
Final Manual	<input type="checkbox"/>	<input type="checkbox"/>

IMEI Process

IMEI Write	<input checked="" type="checkbox"/>	<input type="checkbox"/>
IMEI Check	<input checked="" type="checkbox"/>	<input type="checkbox"/>
MDL+2nd Check	<input type="checkbox"/>	<input type="checkbox"/>
MDL Rework	<input type="checkbox"/>	<input type="checkbox"/>
IMEI Read	<input type="checkbox"/>	<input type="checkbox"/>

WLAN
Power Off-On before WLAN
Bluetooth

Test Condition

Calibration
Real CAL Cycle: on every
20 default CALs

Calibration Mode:

Final
Supply RF Signal by:

Test Signal Mode:

Developer Mode

IMEI

Use RFSM
Use Second PC
Save ODS

System Config.

Language:

Line Name:

Line Type:

of Phone:

Start Number of Jig:

IP Address: 10.244.114.62

Operation Condition

Model Information

Hardware Config

Signal Loss Config.

Terminal Config.

WATS Calibration

Setting End Band

IMEI SVC&Repair Option

Operation Condition

OK

9. Click 'Port Setting'

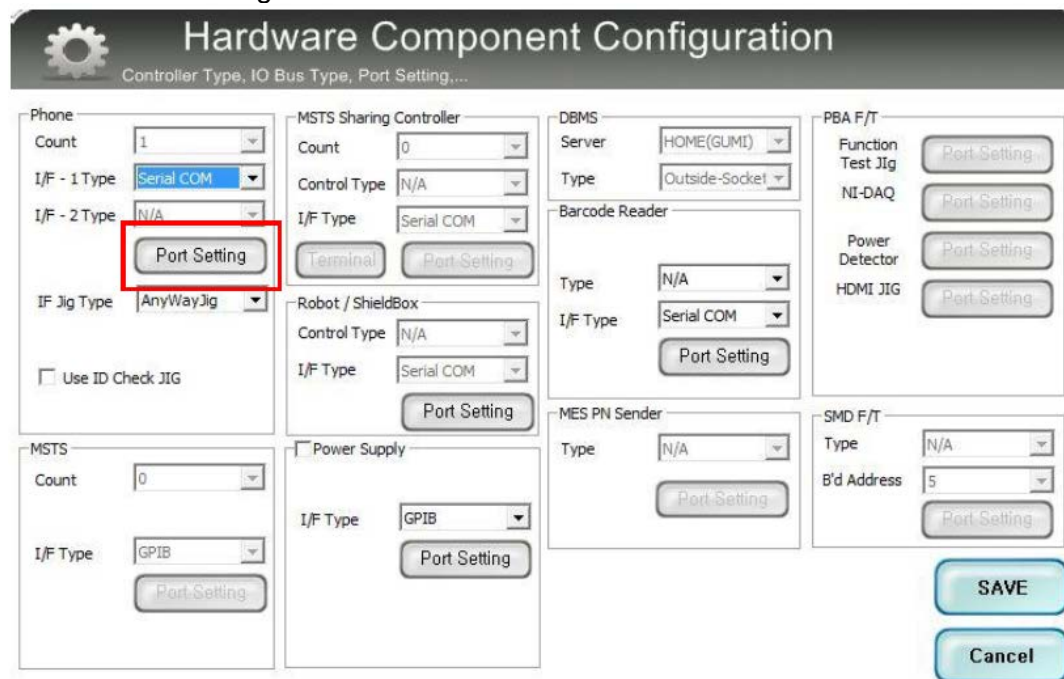

Hardware Component Configuration
Controller Type, IO Bus Type, Port Setting,...

Phone

Count:

I/F - 1 Type:

I/F - 2 Type:

Port Setting

IF Jig Type:

Use ID Check JIG

MSTS

Count:

I/F Type:

Port Setting

MSTS Sharing Controller

Count:

Control Type:

I/F Type:

Terminal **Port Setting**

Robot / ShieldBox

Control Type:

I/F Type:

Port Setting

Power Supply

I/F Type:

Port Setting

DBMS

Server:

Type:

Barcode Reader

Type:

I/F Type:

Port Setting

MES PN Sender

Type:

Port Setting

PBA F/T

Function Test Jig **Port Setting**

NI-DAQ **Port Setting**

Power Detector **Port Setting**

HDMI JIG **Port Setting**

SMD F/T

Type:

B'd Address:

Port Setting

SAVE

Cancel

6. Level 1 Repair

10. Select Port Number and SAVE

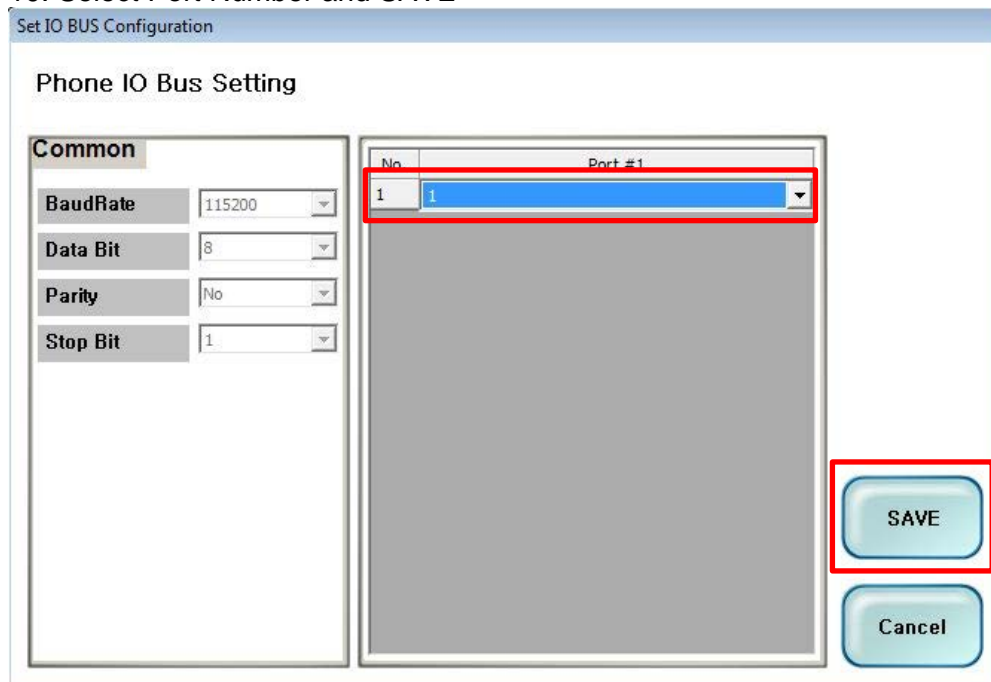

Set IO BUS Configuration

Phone IO Bus Setting

Common

BaudRate: 115200
Data Bit: 8
Parity: No
Stop Bit: 1

No.	Port #1
1	1

SAVE
Cancel

11. Click OK to proceed

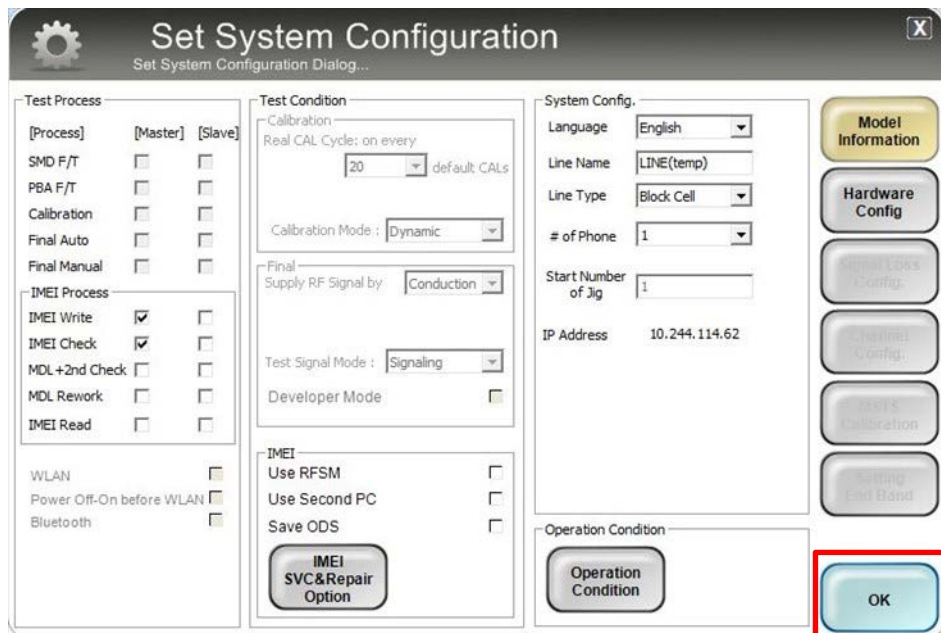

Set System Configuration

Set System Configuration Dialog...

Test Process

[Process] [Master] [Slave]

SMD F/T
PBA F/T
Calibration
Final Auto
Final Manual
IMEI Process
IMEI Write
IMEI Check
MDL +2nd Check
MDL Rework
IMEI Read
WLAN
Power Off-On before WLAN
Bluetooth

Test Condition

Calibration
Real CAL Cycle: on every
20 default CALs
Calibration Mode: Dynamic
Final
Supply RF Signal by: Conduction
Test Signal Mode: Signaling
Developer Mode
IMEI
Use RFSM
Use Second PC
Save ODS
IMEI SVC&Repair Option

System Config.

Language: English
Line Name: LINE(temp)
Line Type: Block Cell
of Phone: 1
Start Number of Jig: 1
IP Address: 10.244.114.62
Operation Condition
Operation Condition

Model Information
Hardware Config
Signal Loss Config.
Channel Config.
Power Calibration
Setting End Band
OK

6. Level 1 Repair

12. Click Model Info and OK when pop-up shows

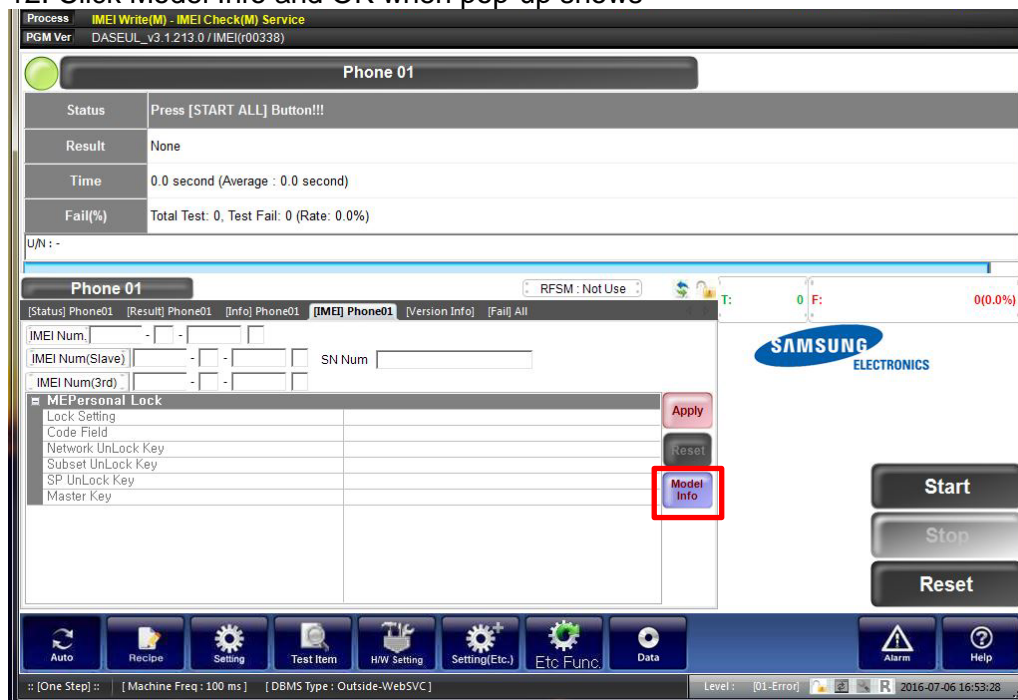

13. Click OK

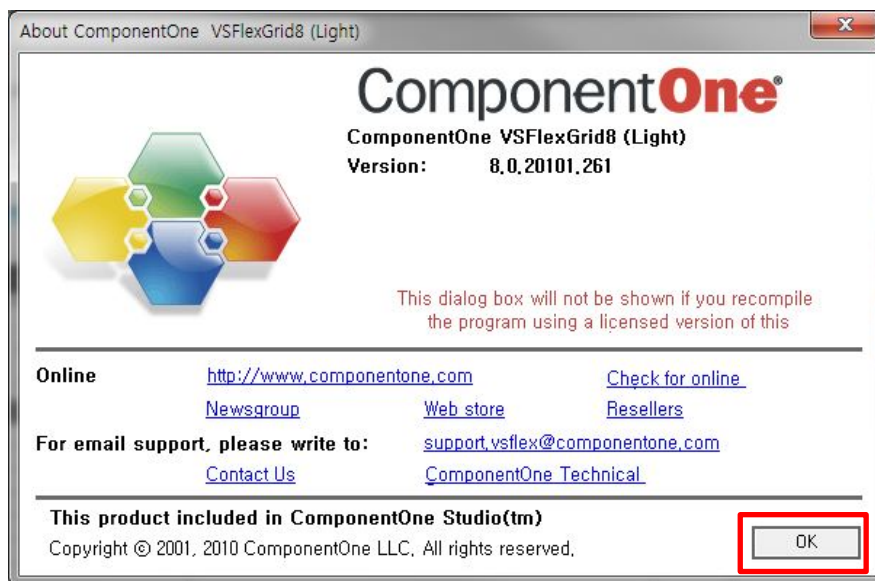

6. Level 1 Repair

14. Input SKU_CODE and BUYER, then click Save button.

※ Refer to HHPsvc→IMEI Review to check SKU Code and buyer

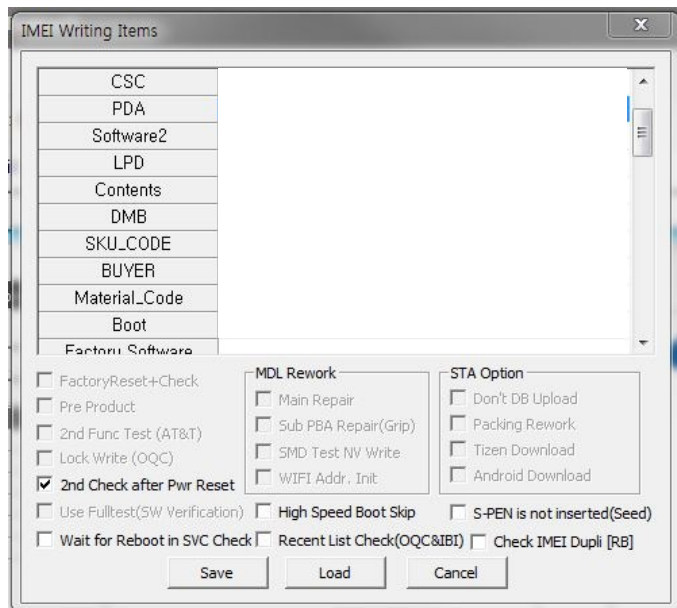

15. Input IMEI Number and click Apply

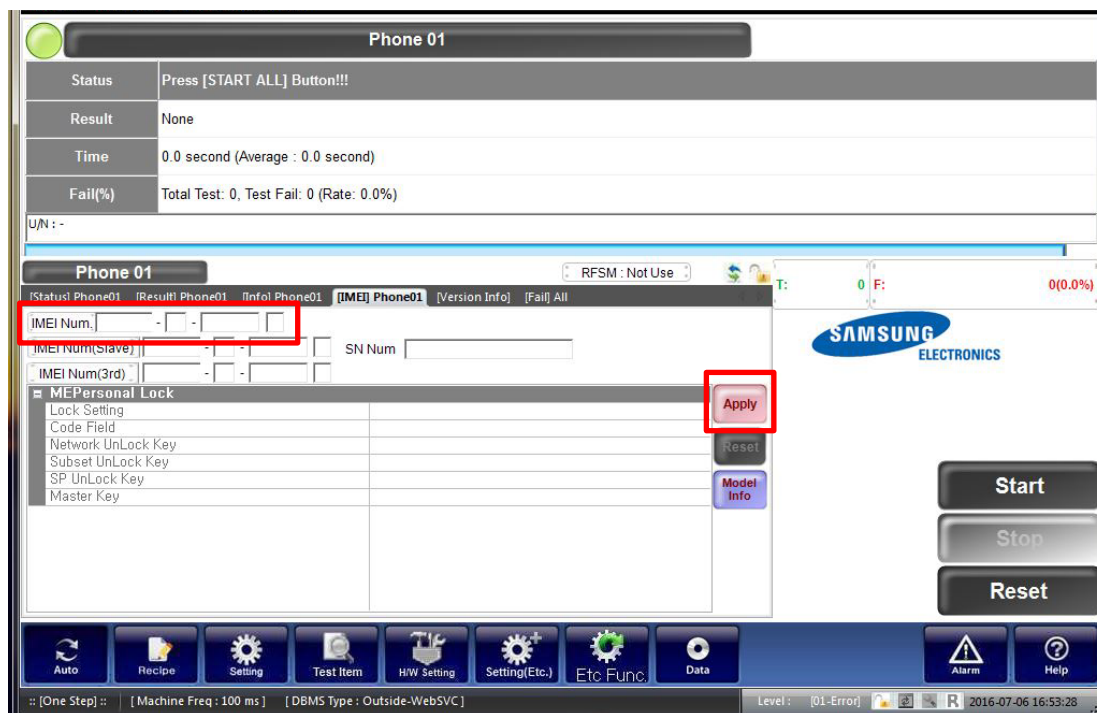

6. Level 1 Repair

16. ① Click Start → ② Input IMEI writing ID and Password & OTP → ③ Input Ticket No

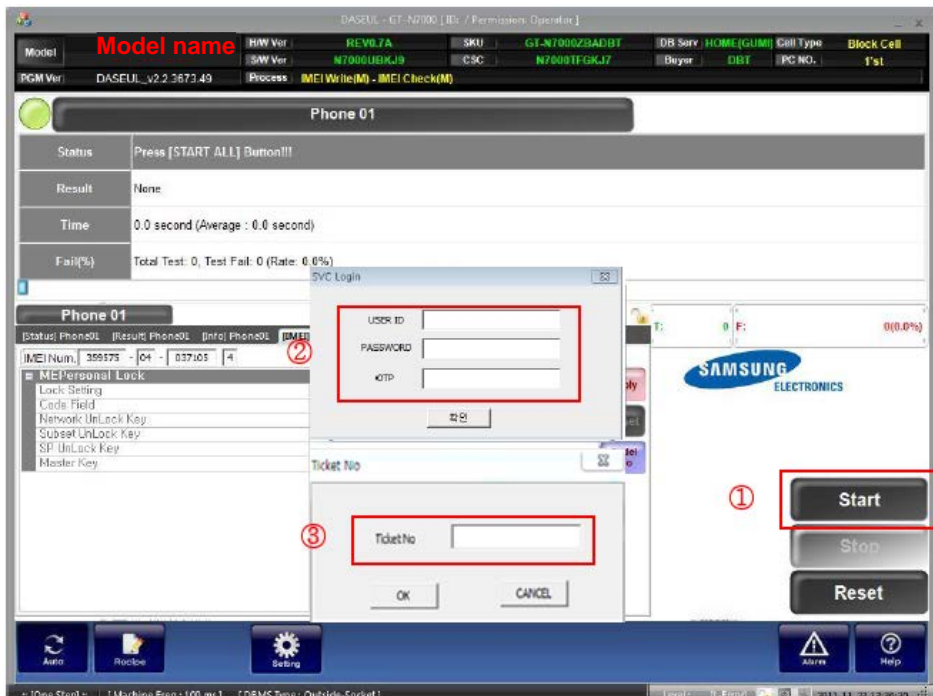

※ OTP(One time Password) : OTP is valid for 6 hours.

After that, you can get new OTP by click the “Forgotten your IMEI OTP PW or Create new IMEI OTP PW” button.

☞ OTP Location : GSPN → Knowledge → HHP svc → Home

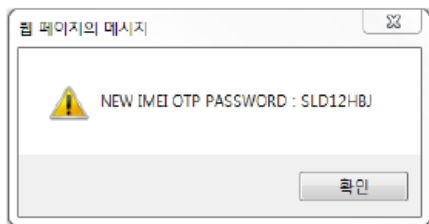
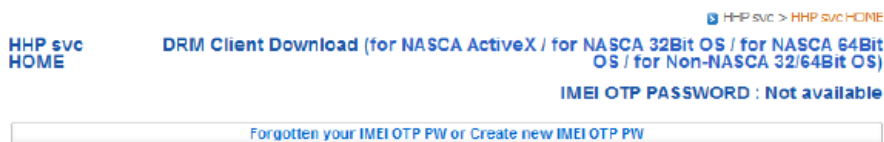

6. Level 1 Repair

17. Connect the phone to Anyway JIG

- ✳ When you connect the phone, the phone should be turned off.
After connecting the phone, the phone will be booted automatically.

18. IMEI Writing Proceeding

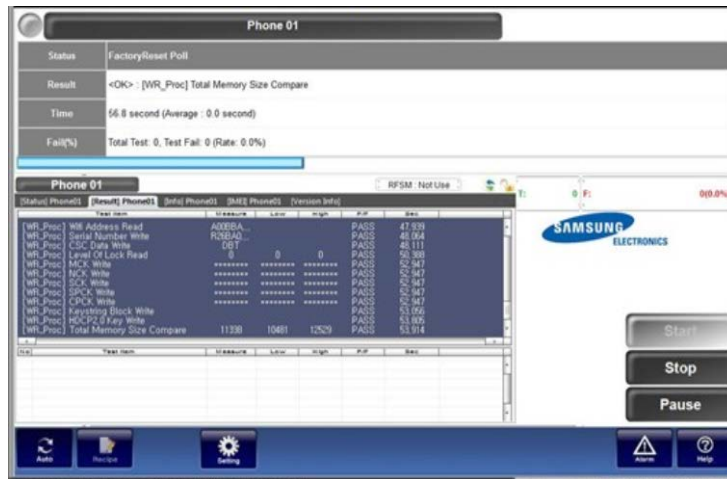

19. IMEI Writing Success

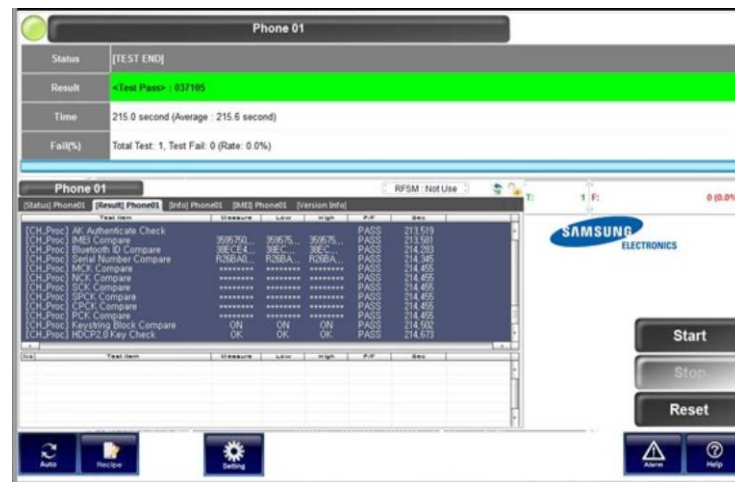

6. Level 1 Repair

6-4. RF Calibration





6-4-1. Required items in order to calibrate RF

- Installation program: RF Calibration Program
- Daseul_Launcher_vx.x.xx.exe
- Daseul_CAL_ALL_Runtime_x.x.xxx.x.CAB
- Model File
- : **Model Name_OPEN_CALIBRATION_Ver_x.x.xxx.x.CAB**

✳ **It is required to use the latest program.**

- Mobile Phone
- R&S CMW500
- E3632A Power Supply
- GPIB Cable (2ea)
- JIG BOX (S103)
- Adapter
- UART Serial Cable
- IF Cable (GH81-11962R)

❖ Table of test cables

RF Cable (Manual)	GH81-11962D (2ea)		
	1.35T 		
4 Port Divider	GH81-11962A Divider 	GH81-11962B Divider Cable 	GH81-11962E 50Ω terminator 

6. Level 1 Repair

❖ Setting

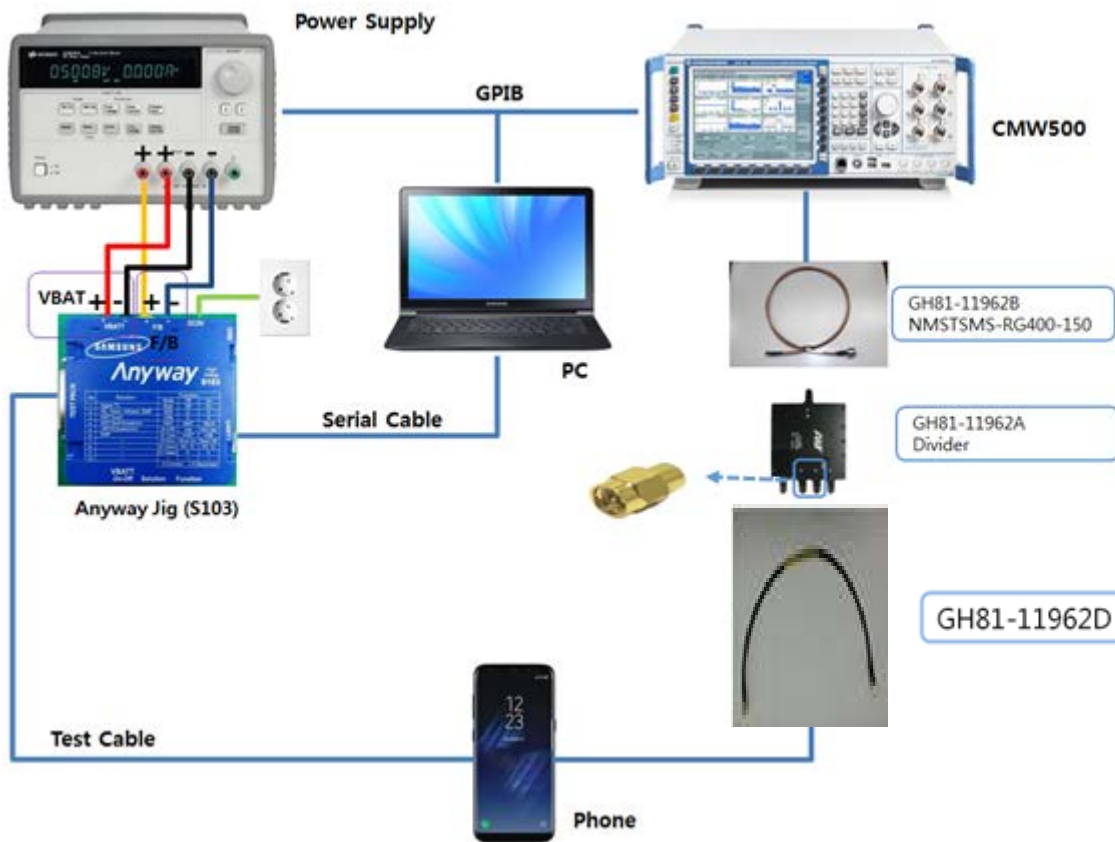

6. Level 1 Repair

6-4-2. RF Calibration Program

1. Run the RF Calibration Program Launcher, 'DASEUL_Launcher_vx.x.xx.exe'.

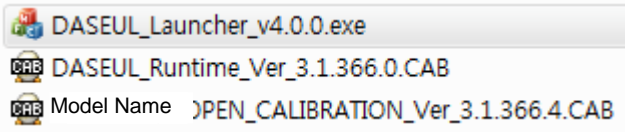

2. Check the 'Calibration' option and Click 'Extract & Run'.

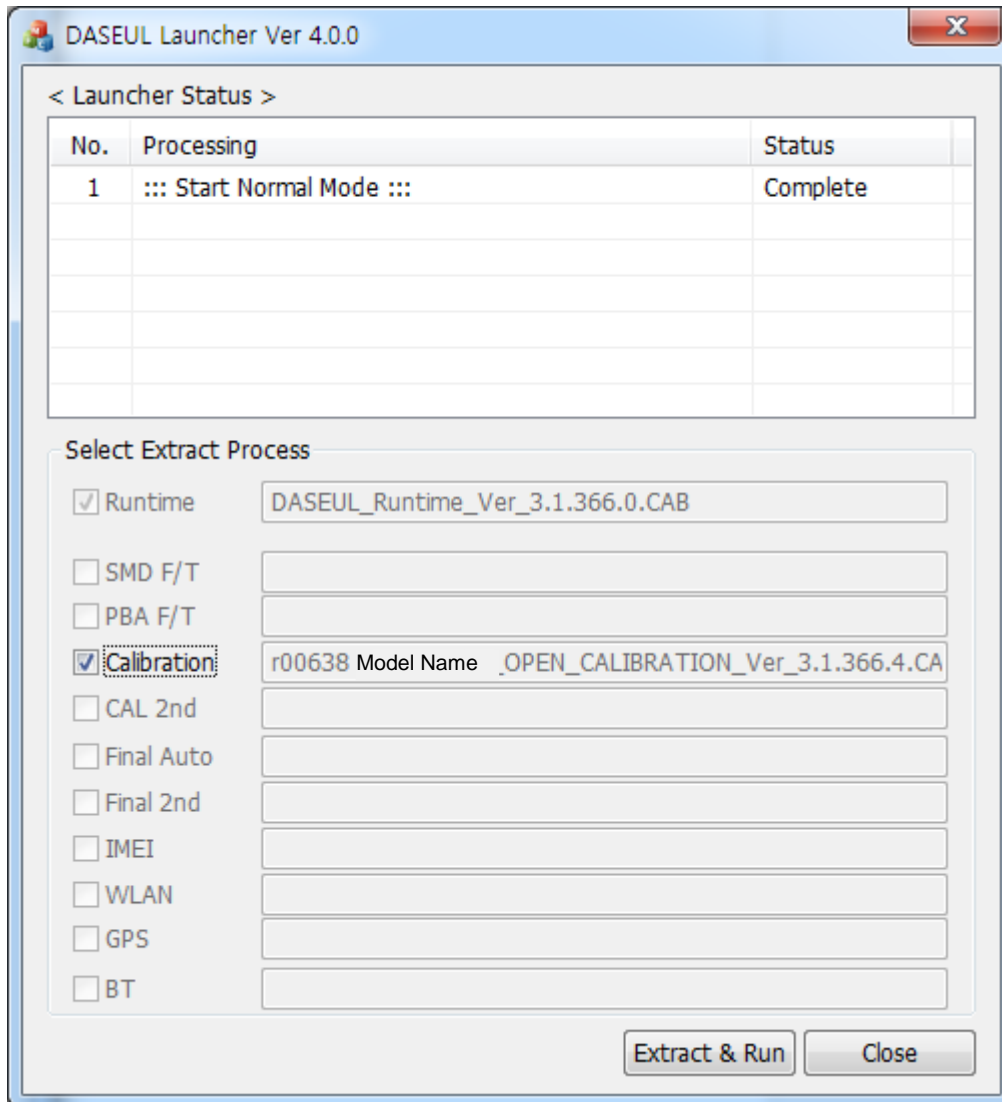

6. Level 1 Repair

3. Check the 'CAL' and open the [model file](#), then select 'Start' button.

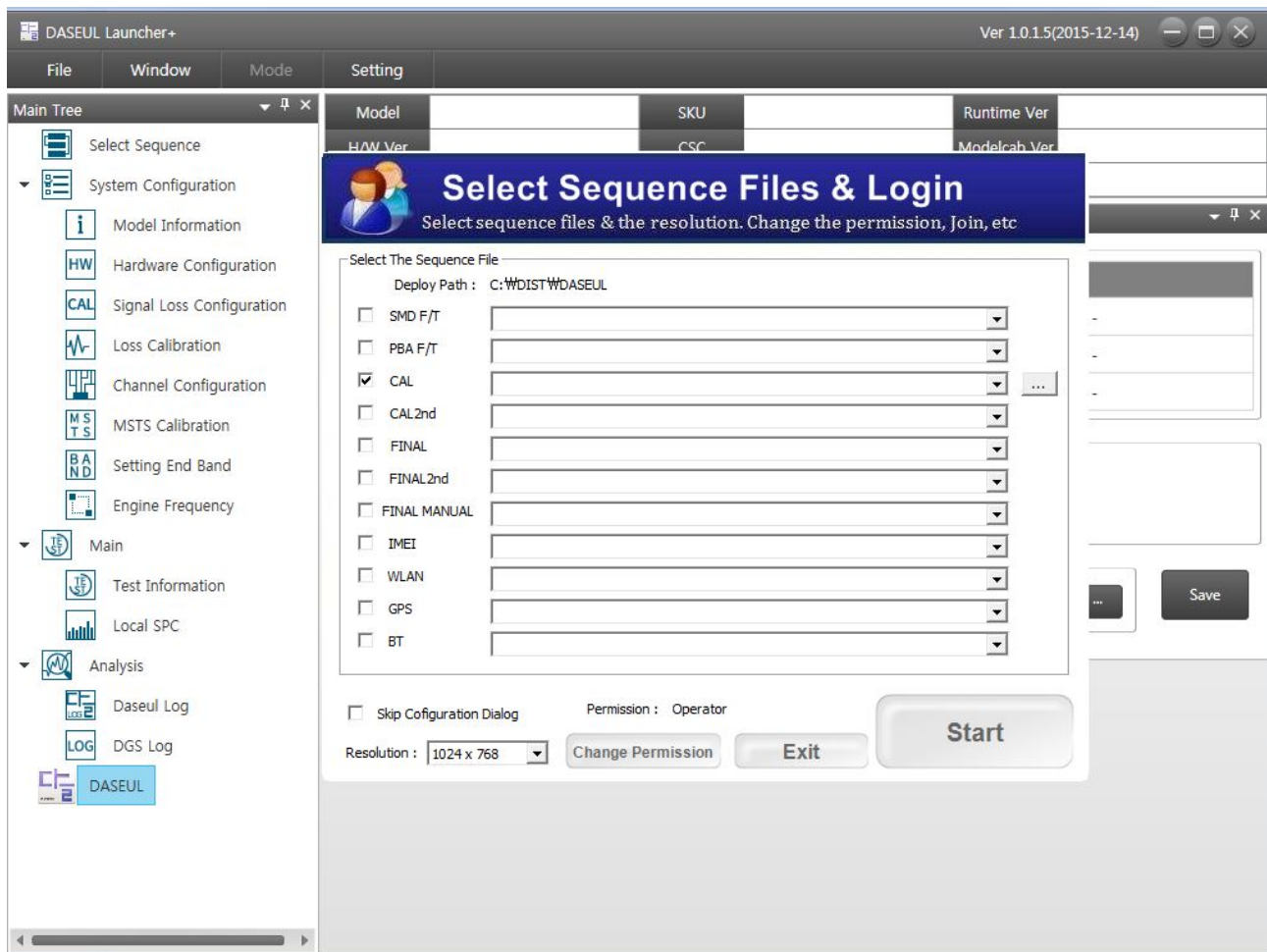

6. Level 1 Repair

4. Change the Line Type to 'Block Cell' and disable 'Smart Cloud Cell'.

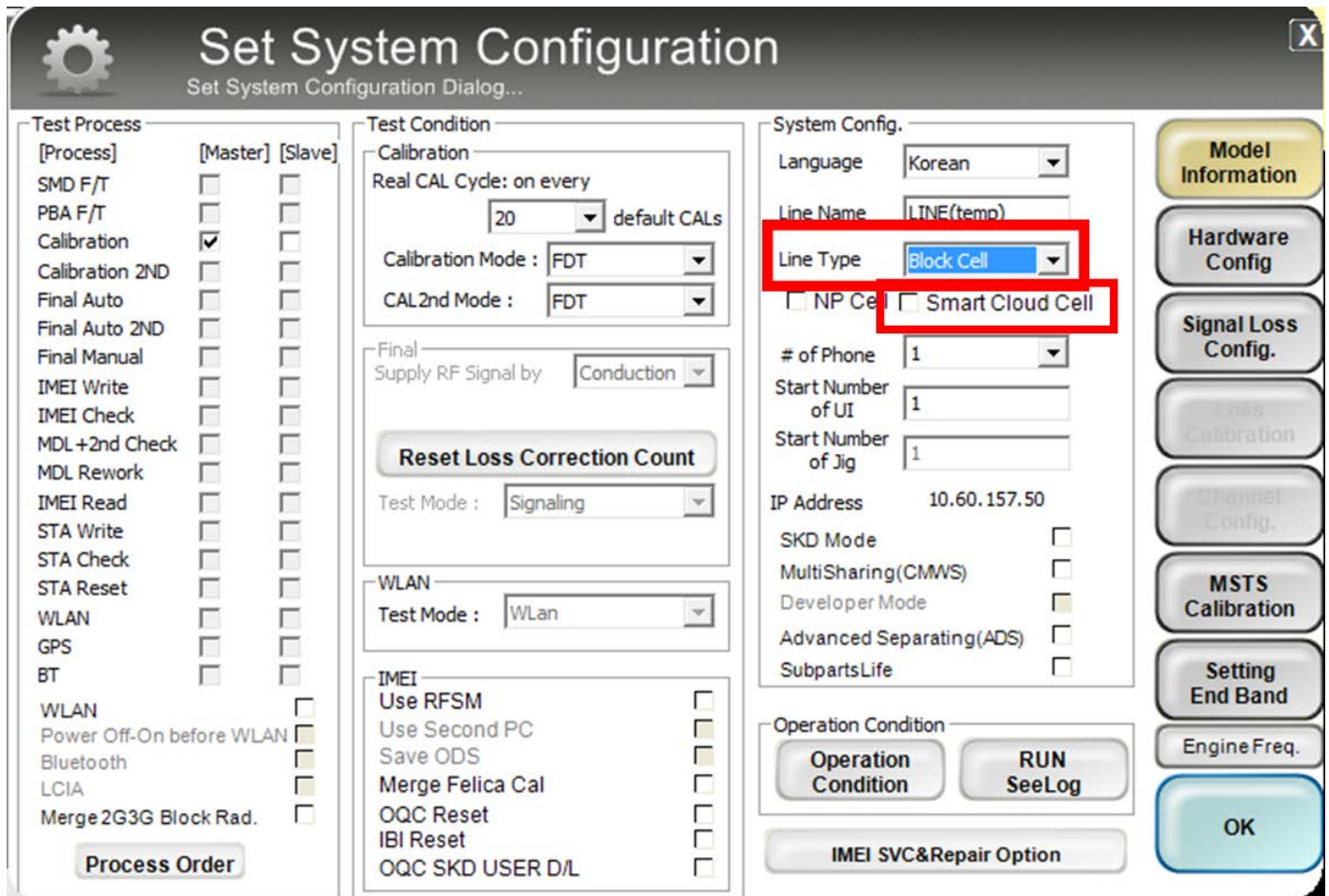

Set System Configuration
Set System Configuration Dialog...

Test Process

[Process]	[Master]	[Slave]
SMD F/T	<input type="checkbox"/>	<input type="checkbox"/>
PBA F/T	<input type="checkbox"/>	<input type="checkbox"/>
Calibration	<input checked="" type="checkbox"/>	<input type="checkbox"/>
Calibration 2ND	<input type="checkbox"/>	<input type="checkbox"/>
Final Auto	<input type="checkbox"/>	<input type="checkbox"/>
Final Auto 2ND	<input type="checkbox"/>	<input type="checkbox"/>
Final Manual	<input type="checkbox"/>	<input type="checkbox"/>
IMEI Write	<input type="checkbox"/>	<input type="checkbox"/>
IMEI Check	<input type="checkbox"/>	<input type="checkbox"/>
MDL+2nd Check	<input type="checkbox"/>	<input type="checkbox"/>
MDL Rework	<input type="checkbox"/>	<input type="checkbox"/>
IMEI Read	<input type="checkbox"/>	<input type="checkbox"/>
STA Write	<input type="checkbox"/>	<input type="checkbox"/>
STA Check	<input type="checkbox"/>	<input type="checkbox"/>
STA Reset	<input type="checkbox"/>	<input type="checkbox"/>
WLAN	<input type="checkbox"/>	<input type="checkbox"/>
GPS	<input type="checkbox"/>	<input type="checkbox"/>
BT	<input type="checkbox"/>	<input type="checkbox"/>
WLAN	<input type="checkbox"/>	<input type="checkbox"/>
Power Off-On before WLAN	<input type="checkbox"/>	<input type="checkbox"/>
Bluetooth	<input type="checkbox"/>	<input type="checkbox"/>
LCIA	<input type="checkbox"/>	<input type="checkbox"/>
Merge 2G3G Block Rad.	<input type="checkbox"/>	<input type="checkbox"/>

Test Condition

Calibration
Real CAL Cycle: on every default CALs

Calibration Mode :

CAL2nd Mode :

Final
Supply RF Signal by

Reset Loss Correction Count

Test Mode :

WLAN
Test Mode :

IMEI
Use RFSM
Use Second PC
Save ODS
Merge Felica Cal
OQC Reset
IBI Reset
OQC SKD USER D/L

System Config.

Language

Line Name

Line Type

NP Cell Smart Cloud Cell

of Phone

Start Number of UI

Start Number of Jig

IP Address

SKD Mode

MultiSharing(CMWS)

Developer Mode

Advanced Separating(ADS)

SubpartsLife

Operation Condition

Model Information

6. Level 1 Repair

5. Set the GPIB address of MSTS(CMW500) and Power Supply(E3632A) to enter 'Hardware Config' and 'Save'. (Check the GPIB address of equipments in advance)

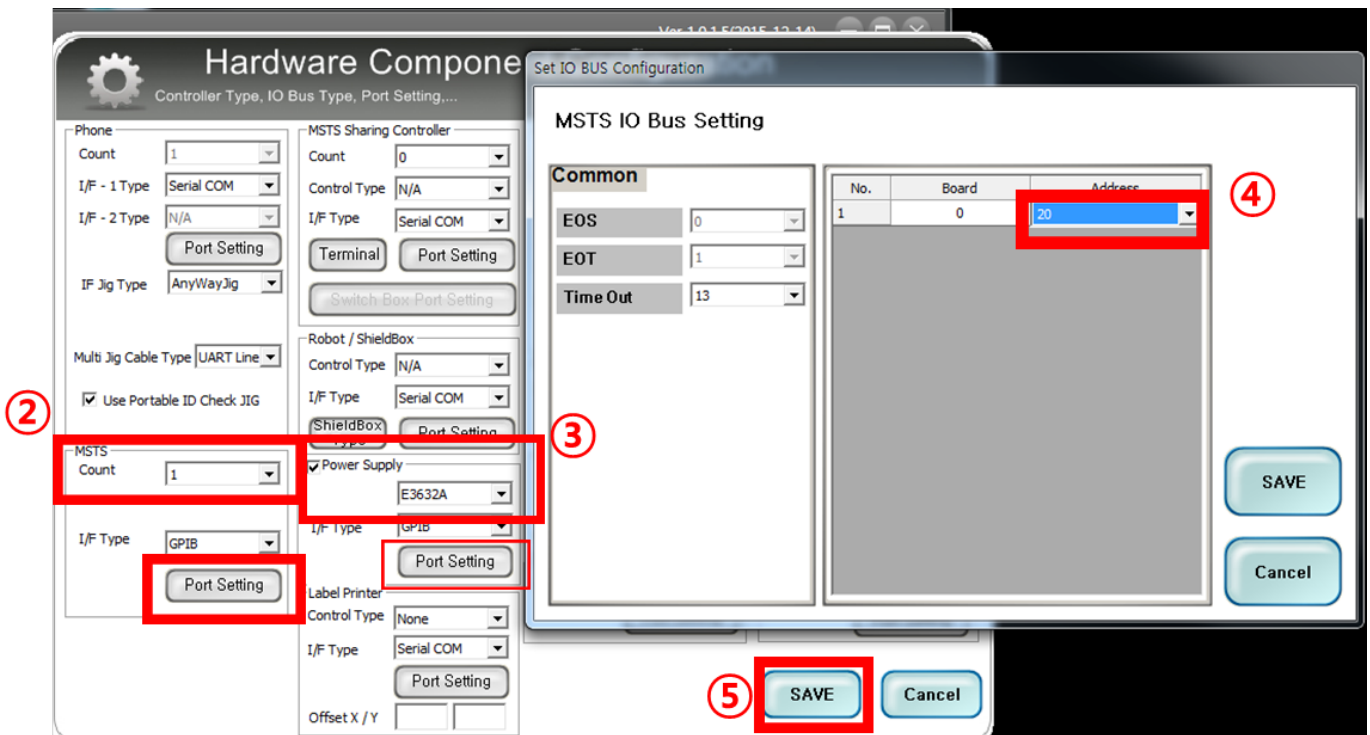
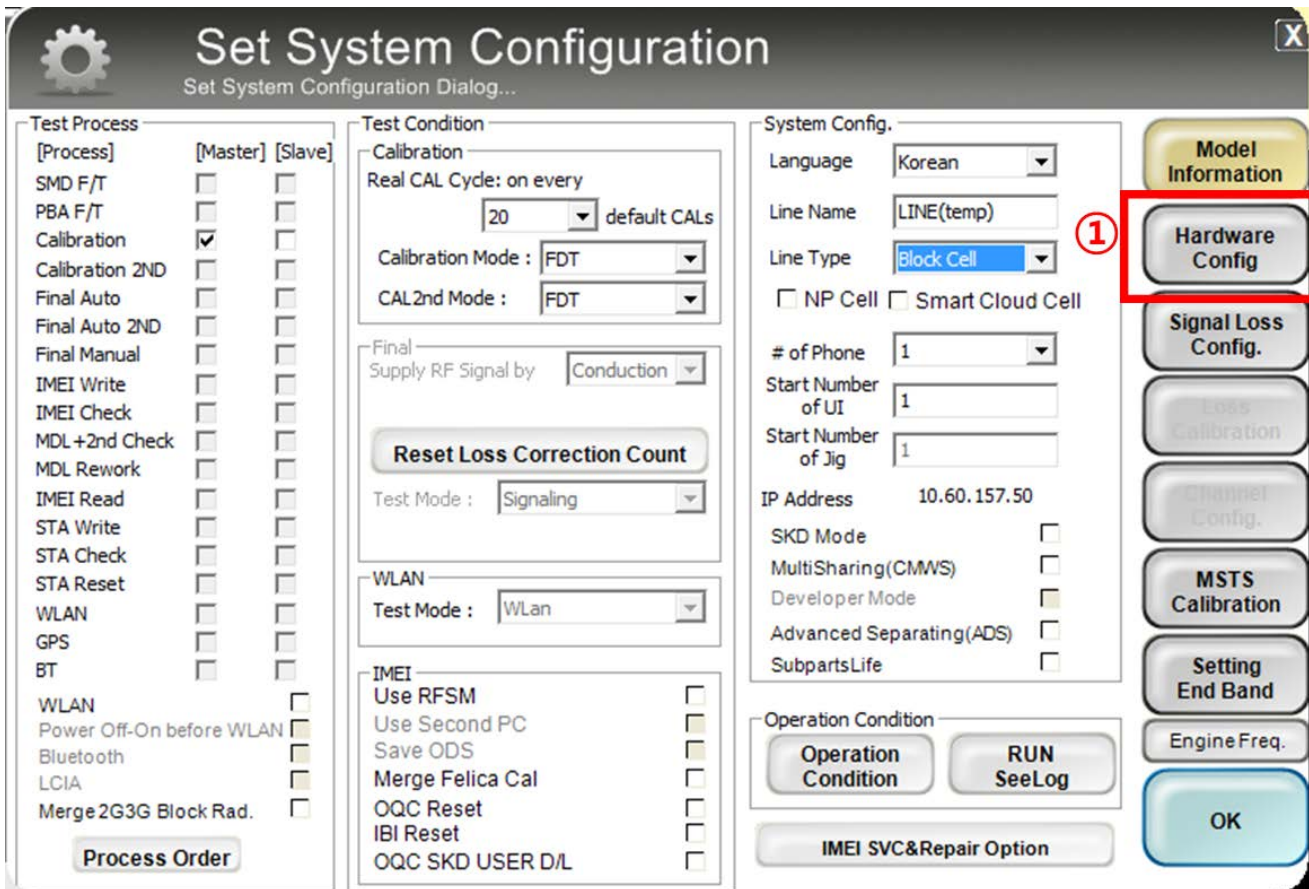

6. Level 1 Repair

6. Press 'OK' to start RF Calibration after completing all settings.

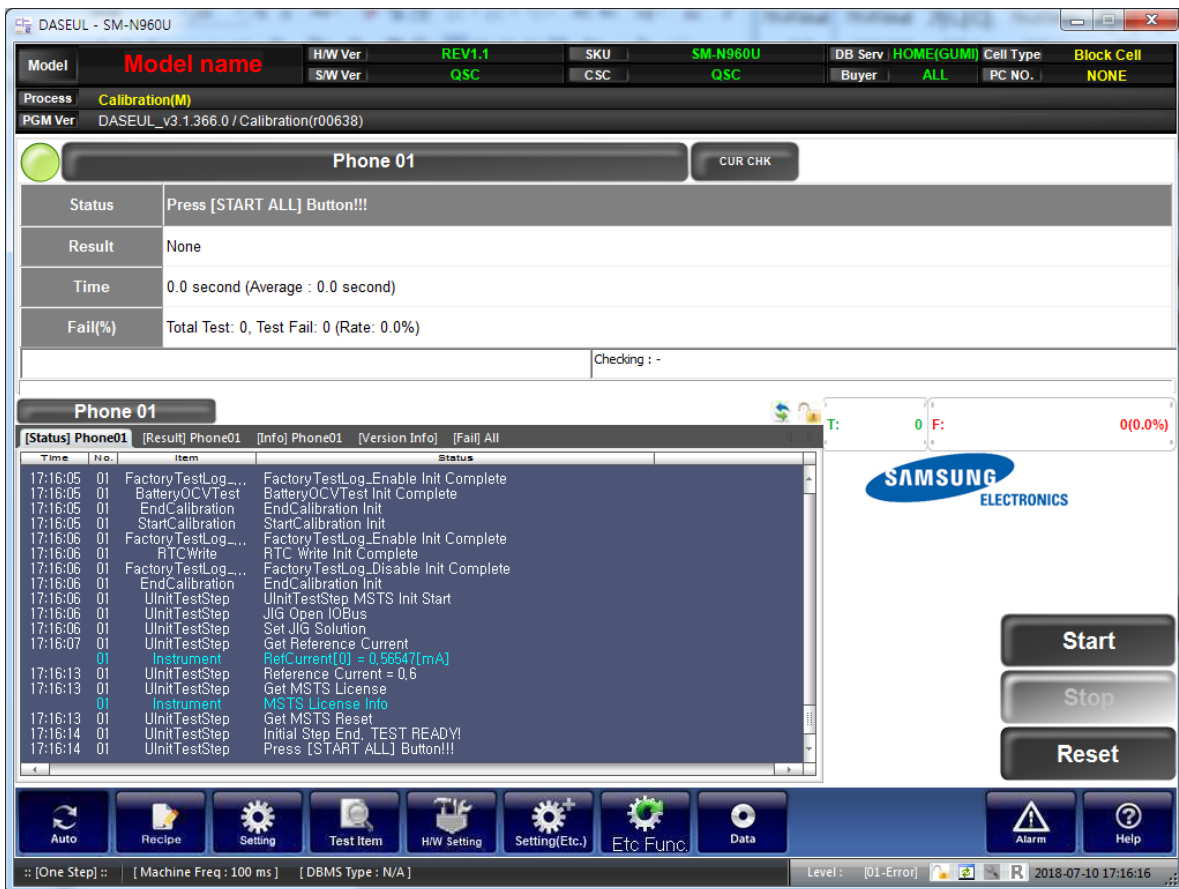
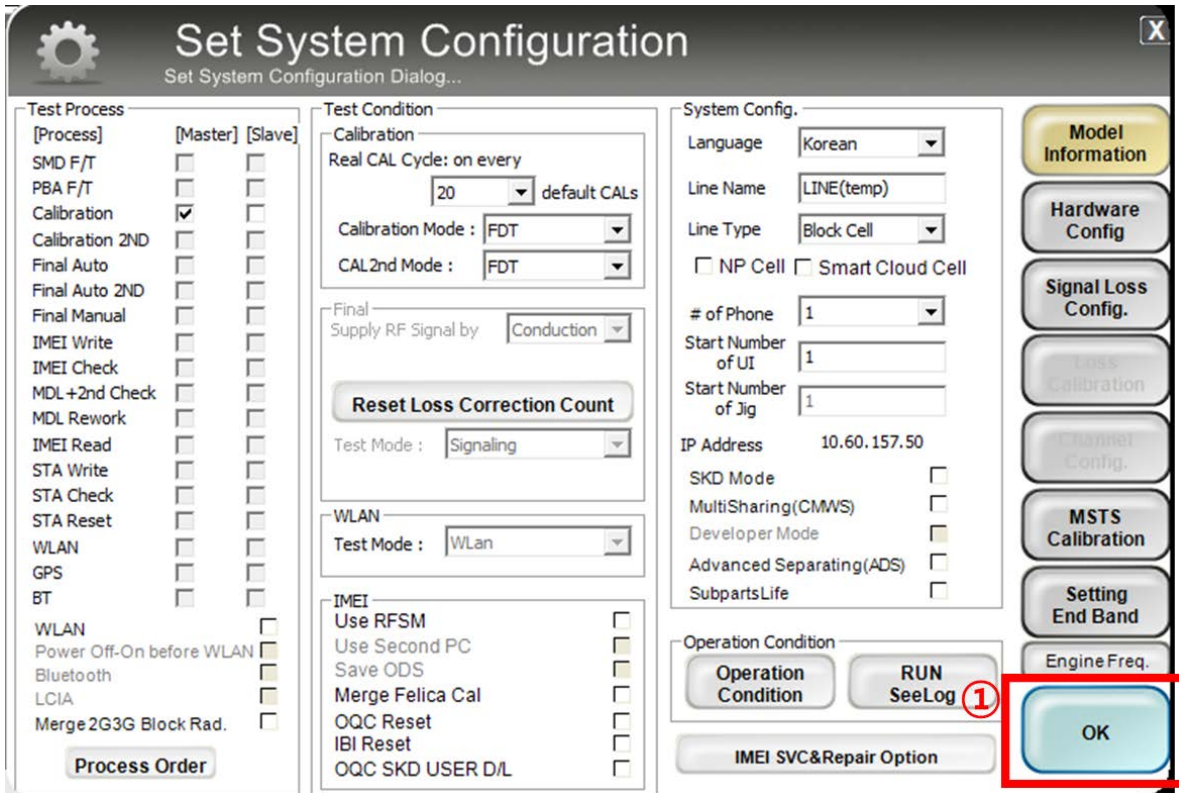

9. Reference Abbreviation

Reference Abbreviation

- **AAC**: Advanced Audio Coding.
- **AVC** : Advanced Video Coding.
- **BER** : Bit Error Rate
- **BPSK**: Binary Phase Shift Keying
- **CA** : Conditional Access
- **CDM** : Code Division Multiplexing
- **C/I** : Carrier to Interference
- **DMB** : Digital Multimedia Broadcasting
- **EN** : European Standard
- **ES** : Elementary Stream
- **ETSI**: European Telecommunications Standards Institute
- **MPEG**: Moving Picture Experts Group
- **PN** : Pseudo-random Noise
- **PS** : Pilot Symbol
- **QPSK**: Quadrature Phase Shift Keying
- **RS** : Reed-Solomon
- **SI** : Service Information
- **TDM** : Time Division Multiplexing
- **TS** : Transport Stream