

2. Specification

2-1. GSM General Specification

Item		GSM850	EGSM 900	DCS1800	PCS1900
Freq. Band[MHz] Uplink/Downlink		824~849 869~894	880~915 925~960	1710~1785 1805~1880	1850~1910 1930~1990
ARFCN range		128~251	0~124 & 975~1023	512~885	512~810
Tx/Rx spacing		45MHz	45MHz	95MHz	80MHz
Mod. Bit rate/ Bit Period		270.833kbps 3.692us	270.833kbps 3.692us	270.833kbps 3.692us	270.833kbps 3.692us
Time Slot Period/ Frame Period		576.9us 4.615ms	576.9us 4.615ms	576.9us 4.615ms	576.9us 4.615ms
Modulation	GSM/ GPRS	0.3GMSK	0.3GMSK	0.3GMSK	0.3GMSK
MS Power		33dBm ~5dBm	33dBm ~5dBm	30dBm ~0dBm	30dBm ~0dBm
Power Class		5pcl ~ 19pcl	5pcl ~ 19pcl	0pcl ~ 15pcl	0pcl ~ 15pcl
Sensitivity		-102dBm	-102dBm	-102dBm	-102dBm
TDMA Mux		8	8	8	8
Cell Radius		35Km	35Km	2Km	2Km

2. Specification

2-2. GSM Tx Power Class

GSM850	TX Power control level	EGSM900	TX Power control level	DCS1800	TX Power control level	PCS1900	TX Power control level
33±2 dBm	5	33±2 dBm	5	30±3 dBm	0	30±3 dBm	0
31±2 dBm	6	31±2 dBm	6	28±3 dBm	1	28±3 dBm	1
29±2 dBm	7	29±2 dBm	7	26±3 dBm	2	26±3 dBm	2
27±2 dBm	8	27±2 dBm	8	24±3 dBm	3	24±3 dBm	3
25±2 dBm	9	25±2 dBm	9	22±3 dBm	4	22±3 dBm	4
23±2 dBm	10	23±2 dBm	10	20±3 dBm	5	20±3 dBm	5
21±2 dBm	11	21±2 dBm	11	18±3 dBm	6	18±3 dBm	6
19±2 dBm	12	19±2 dBm	12	16±3 dBm	7	16±3 dBm	7
17±2 dBm	13	17±2 dBm	13	14±3 dBm	8	14±3 dBm	8
15±2 dBm	14	15±2 dBm	14	12±4 dBm	9	12±4 dBm	9
13±2 dBm	15	13±2 dBm	15	10±4 dBm	10	10±4 dBm	10
11±3 dBm	16	11±3 dBm	16	8±4 dBm	11	8±4 dBm	11
9±3 dBm	17	9±3 dBm	17	6±4 dBm	12	6±4 dBm	12
7±3 dBm	18	7±3 dBm	18	4±4 dBm	13	4±4 dBm	13
5±3 dBm	19	5±3 dBm	19	2±5 dBm	14	2±5 dBm	14
				0±5 dBm	15	0±5 dBm	15

2. Specification

2-3. WCDMA General Specification

	WCDMA2100	WCDMA1900	WCDMA850	WCDMA900
Freq. Band[MHz] Uplink/Downlink	1922~1977 2112~2167	1852~1907 1932~1987	824~849 869~894	880~915 925~960
ARFCN range	UL: 9612~9888 DL: 10562~10838	UL: 9262~9538 DL: 9662~9938	UL: 4132~4233 DL: 4357~4458	UL: 2712~2863 DL: 2937~3088
Tx/Rx spacing	190MHz	80MHz	45MHz	45MHz
Mod. Bit rate/ Bit Period	3.84 Mcps	3.84 Mcps	3.84 Mcps	3.84 Mcps
Time Slot Period /Frame Period	Frame Length: 10ms Slot length: 0.667ms	Frame Length: 10ms Slot length: 0.667ms	Frame Length: 10ms Slot length: 0.667ms	Frame Length: 10ms Slot length: 0.667ms
Modulation	QPSK/HQPSK	QPSK/HQPSK	QPSK/HQPSK	QPSK/HQPSK
MS Power	24dBm~-50dBm	24dBm~-50dBm	24dBm~-50dBm	24dBm~-50dBm
Power Class	3(max+24dBm)	3(max+24dBm)	3(max+24dBm)	3(max+24dBm)
Sensitivity	-106.7dBm	-104.7dBm	-104.7dBm	-103.7dBm
TDMA Mux	8	8	8	8
Cell Radius	2Km	2Km	2Km	2Km

2. Specification

2-4. LTE General Specification

	LTE Band1	LTE Band3	LTE Band5	LTE Band7	LTE Band8	LTE Band 20	LTE BAND 40
Freq. Band [MHz] Uplink/ Downlink	1920~1980 2110~2170	1710~1785 1805~1880	824~849 869~894	2500~2570 1805~1880	2500~2570 1805~1880	704~716 734~746	2300~2400
ARFCN range	UL: 18000~18599 DL: 0~599	UL: 19200~19950 DL: 1805~1880	UL: 20400~20649 DL: 2400~2649	UL: 20750~21449 DL: 2750~3449	UL: 21450~21799 DL: 3450~3799	UL: 24150~24449 DL: 6150~6449	38650~39649
Tx/Rx spacing	190MHz	95MHz	45MHz	120MHz	45MHz	41MHz	
Channel Bandwidth	60 MHz	75 MHz	25 MHz	70 MHz	35 MHz	30 MHz	5/10/15/20 MHz
Modulation	QPSK, 16/64QAM	QPSK, 16/64QAM	QPSK, 16/64QAM	QPSK, 16/64QAM	QPSK, 16/64QAM	QPSK, 16/64QAM	QPSK, 16/64QAM
MS Power (MPR)	-35~25.7 dBm	-35~25.7 dBm	-35~25.7 dBm	-35~25.7 dBm	-35~25.7 dBm	-35~25.7 dBm	35~25.7dBm
Sensitivit (QPSK) (BW 10MHz)	-94 dBm	-92 dBm	-92 dBm	-95dBm	-95dBm	-95dBm	-97dBm
Cell Radius	>5Km	>5Km	>5Km	>5Km	>5Km	>5Km	>5Km

3. Operation Instruction and Installation

Main Function

Item	Description
OS	Android 6.0.1
RF	2G GSM, 3G WCDMA, 4G LTE FDD,
Battery	3100mAh
Base Band	1.2GHz Quad core
Other RF	Bluetooth 4.1, WIFI 802.11 b/g/n 2.4GHz,USB2.0, GPS, Glonass
Camera	13MP AF with LED Flash , 5MP Front camera with LED Flash
LCD	5.2" / 720*1280(Super AMOLED)
Memory	16GB eMMC,2Gb DDR
Sensor	Accelerometer, Proximity, Hall IC, Grip,
Accessory	Charger: 5V/1.55A, White Data Cable : 3.0PI, 0.8M, White Ear phone: 3.5PI, 4Pin

9. Reference Abbreviate

Reference Abbreviate

- **AAC**: Advanced Audio Coding.
- **AVC** : Advanced Video Coding.
- **BER** : Bit Error Rate
- **BPSK**: Binary Phase Shift Keying
- **CA** : Conditional Access
- **CDM** : Code Division Multiplexing
- **C/I** : Carrier to Interference
- **DMB** : Digital Multimedia Broadcasting
- **EN** : European Standard
- **ES** : Elementary Stream
- **ETSI**: European Telecommunications Standards Institute
- **MPEG**: Moving Picture Experts Group
- **PN** : Pseudo-random Noise
- **PS** : Pilot Symbol
- **QPSK**: Quadrature Phase Shift Keying
- **RS** : Reed-Solomon
- **SI** : Service Information
- **TDM** : Time Division Multiplexing
- **TS** : Transport Stream

1. Safety Precautions

1-1. Repair Precaution

Before attempting any repair or detailed tuning, shield the device from RF noise or static electricity discharges.

Use only demagnetized tools that are specifically designed for small electronic repairs, as most electronic parts are sensitive to electromagnetic forces.

Use only high quality screwdrivers when servicing products. Low quality screwdrivers can easily damage the heads of screws.

Use only conductor wire of the properly gauge and insulation for low resistance, because of the low margin of error of most testing equipment.

We recommend 22-gauge twisted copper wire.

Hand-soldering is not recommended, because printed circuit boards (PCBs) can be easily damaged, even with relatively low heat. Never use a soldering iron with a power rating of more than 100 watts and use only lead-free solder with a melting point below 250°C (482°F).

Prior to disassembling the battery charger for repair, ensure that the AC power is disconnected.

Always use the replacement parts that are registered in the SEC system. Third-party replacement parts may not function properly.

1.Safety Precautions

1-2. ESD(Electrostatically Sensitive Devices) Precaution

Many semiconductors and ESDs in electronic devices are particularly sensitive to static discharge and can be easily damaged by it. We recommend protecting these components with conductive anti-static bags when you store or transport them.

Always use an anti-static strap or wristband and remove electrostatic buildup or dissipate static electricity from your body before repairing ESDs.

Ensure that soldering irons have AC adapter with ground wires and that the ground wires are properly connected.

Use only desoldering tools with plastic tips to prevent static discharge.

Properly shield the work environment from accidental electrostatic discharge before opening packages containing ESDs.

The potential for static electricity discharge may be increased in low humidity environments, such as air-conditioned rooms. Increase the airflow to the working area to decrease the chance of accidental static electricity discharges.

6. Level 1 Repair

6-1. S/W Download

6-1-1. Prepare for S/W Downloading

- Diagram of connection

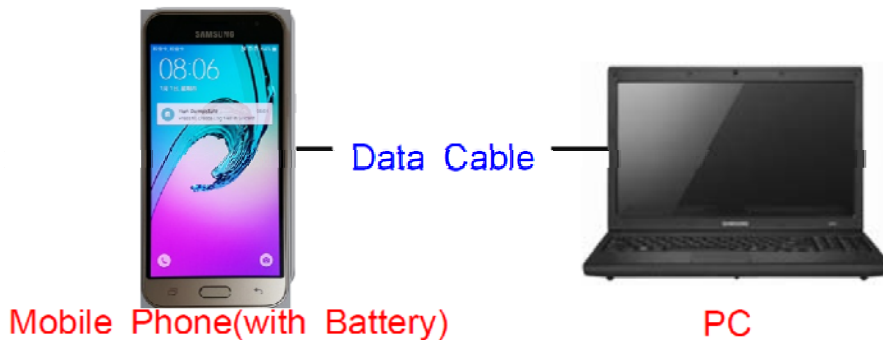

6-2-2. How to download S/W

1) Downloading Binary Files

- Binary file for downloading SM-J510FN
 - AP_XXXX.tar.md5
 - BL_XXXX.tar.md5
 - CP_XXXX.tar.md5
 - CSC_XXXX.tar.md5(file size is about 2.2GB)

2) Prepare for Downloading

- Downloader Program ([Odin3 v3.10.exe](#))
- SM-J510FN Mobile Phone
- Data Cable
- Binary files

3) Boot the mobile phone by pressing 'Home + Vol Down + Power key at the same time, If you do properly, you can see the following message on the main LCD as the following.

6. Level 1 Repair

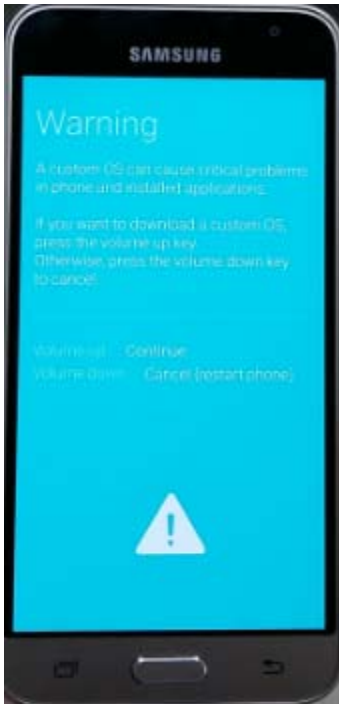

4) Press the Vol Up Key again, and you will see below message on Main LCD.

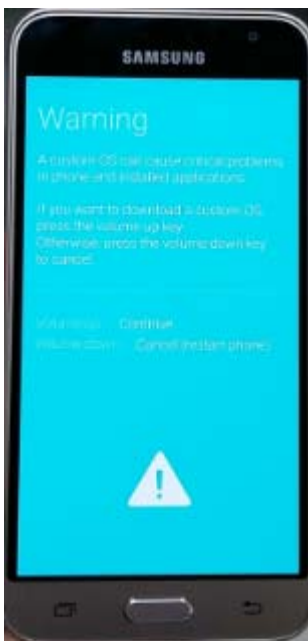

“

Downloading...

”

5) Load the binary download program.

6. Level 1 Repair

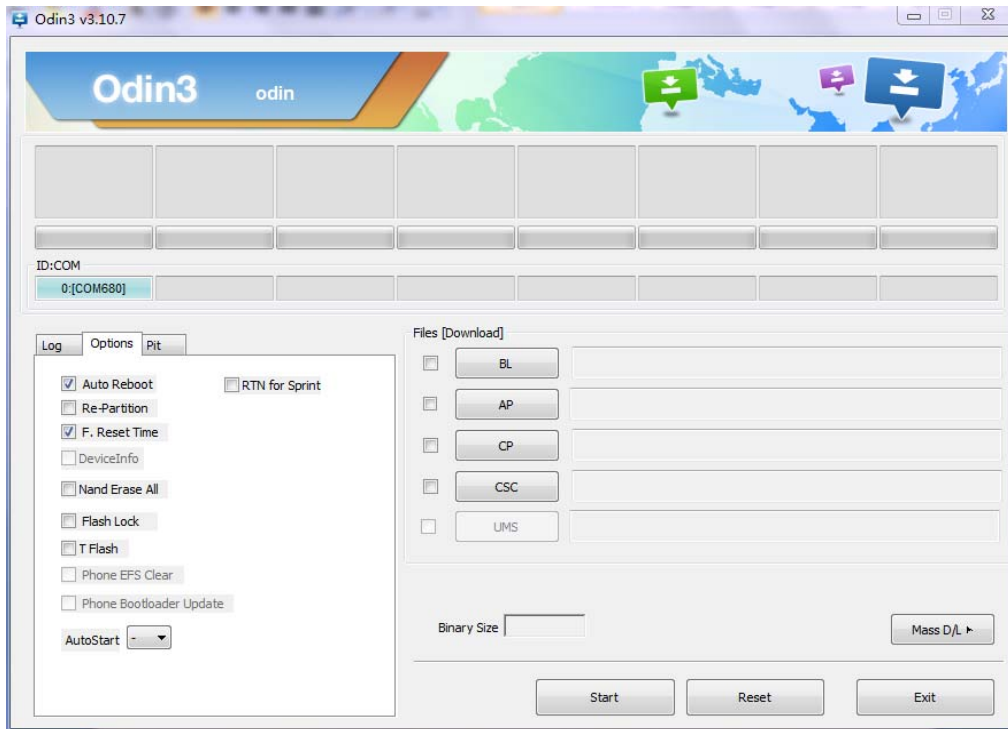

6) Choose "RTN for Sprint"

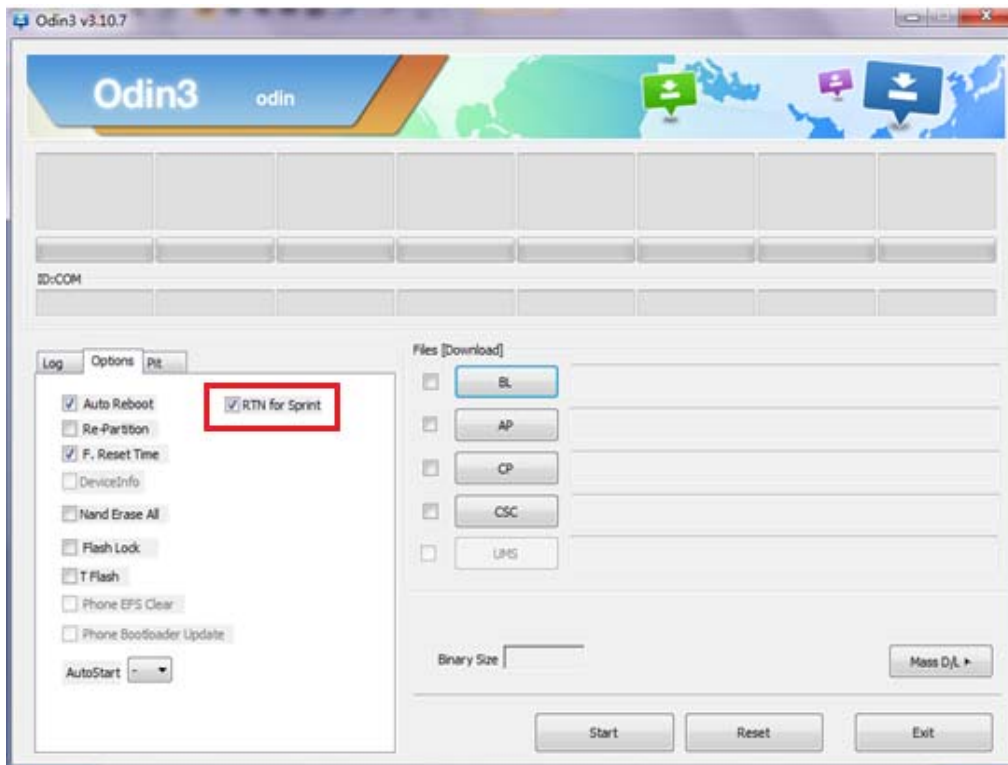

7) Select the file as above:

- AP_XXXX.tar.md5
- BL_XXXX.tar.md5
- CP_XXXX.tar.md5
- CSC_XXXX.tar.md5

6. Level 1 Repair

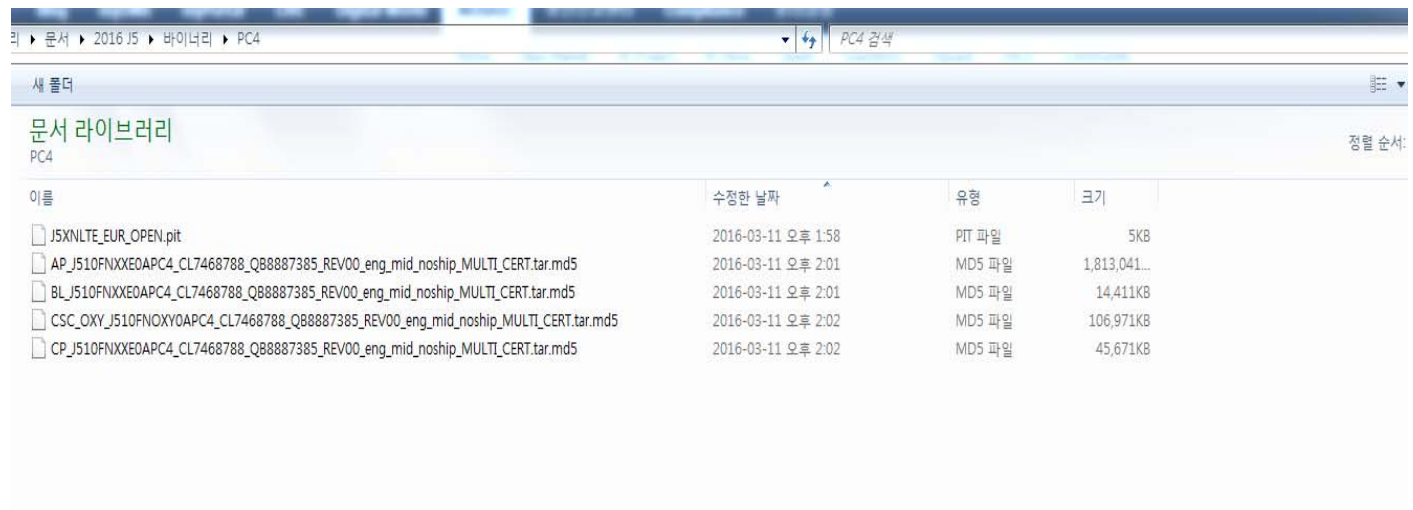

7) Connect mobile and computer. The program show as follow.

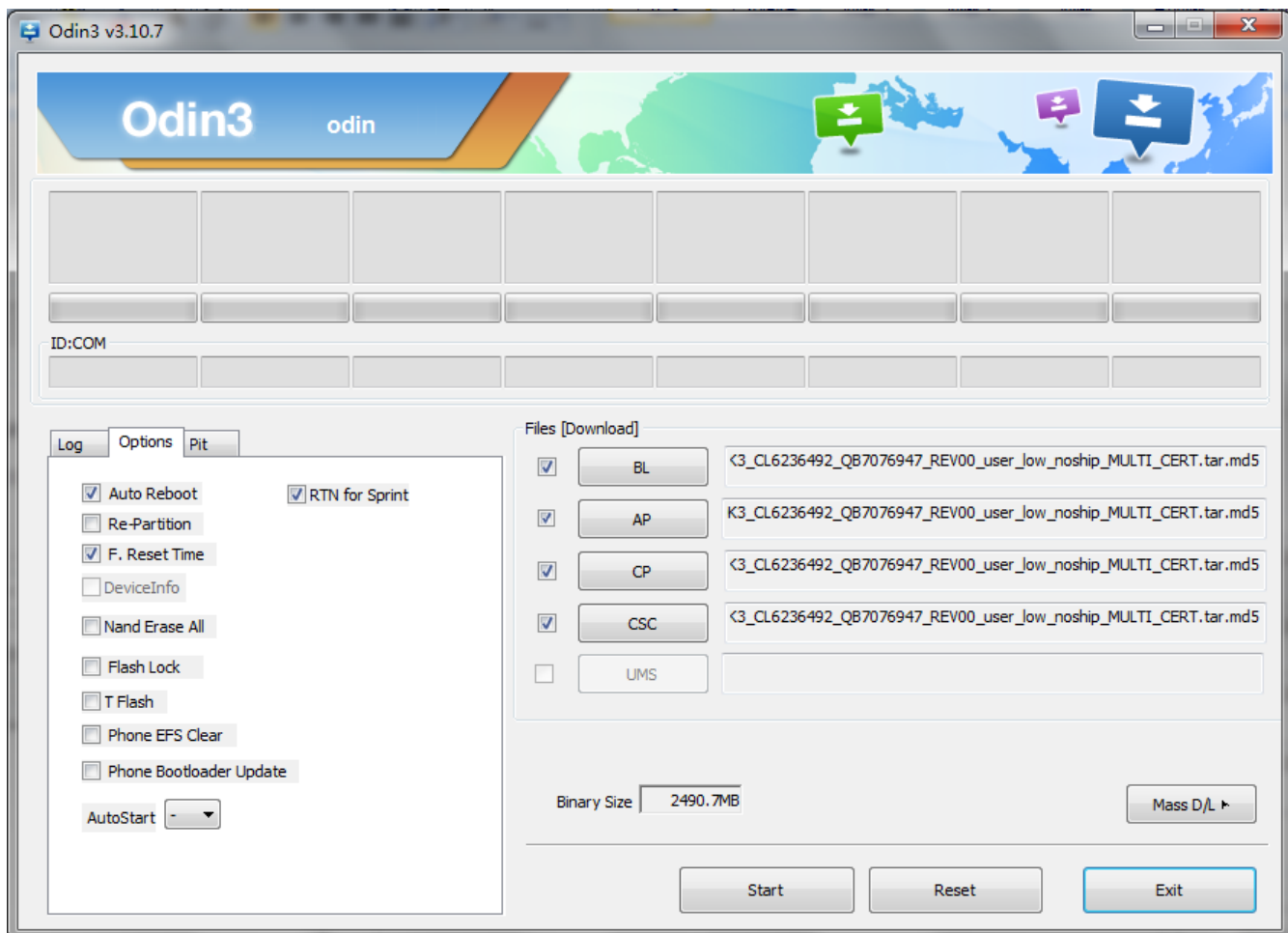

8) Now press the button "Start".

9) Now it's time to take a rest and finish the downloading.

10) After finished downloading of phone binary, the mobile phone will restart automatically.

6. Level 1 Repair

11) Once the device boots up, you can check the version of the binary file or name by pressing the following code in sequence;

***#1234#**

You can perform Factory Reset by Settings → Accounts → Backup and reset

※ **Caution. Never disconnect during the S/W downloading.**

6-2 IMEI writing

6-2-1 Preparation

- New IMEI writing Program has been released.
- Supported Model : Models which CAB files are uploaded on HHPsvc INI File category, instead of ini file.
- Refer to below IMEI writing procedure.

- H/W

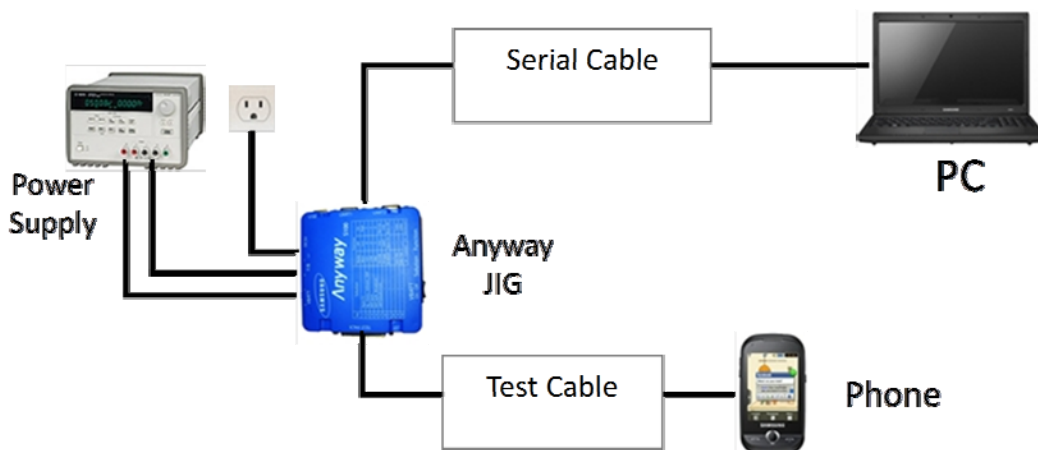

6. Level 1 Repair

- S/W

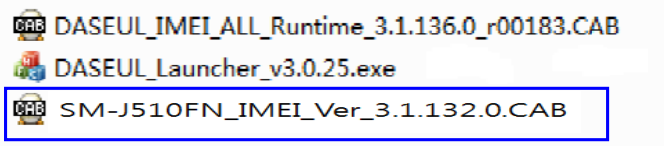
① Library Install	To use Daseul, library files should be installed. Refer to SVC Bulletin “(11-82) Daseul (New IMEI writing Program) Library Install guide_rev1.0”
② Launcher	DASEUL_SVC_Launcher_v3_0_25 or higher -Uploaded on HHPsvc Notice
③ Runtime File	1. DASEUL_IMEI_ALL_Runtime_3.1.136_r00183 .CAB or higher -Uploaded on HHPsvc Notice 2. Make 'ModelName' folder at the same position with launcher & Runtime file. 
④ Model File	Copy Model File under the 'Model Name' folder

6. Level 1 Repair

6-2-2 IMEI writing Process

1. Run DASEUL_SVC_Launcher_v3_0_25

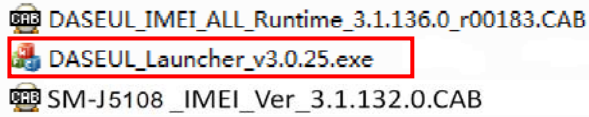

2. Select Service Mode

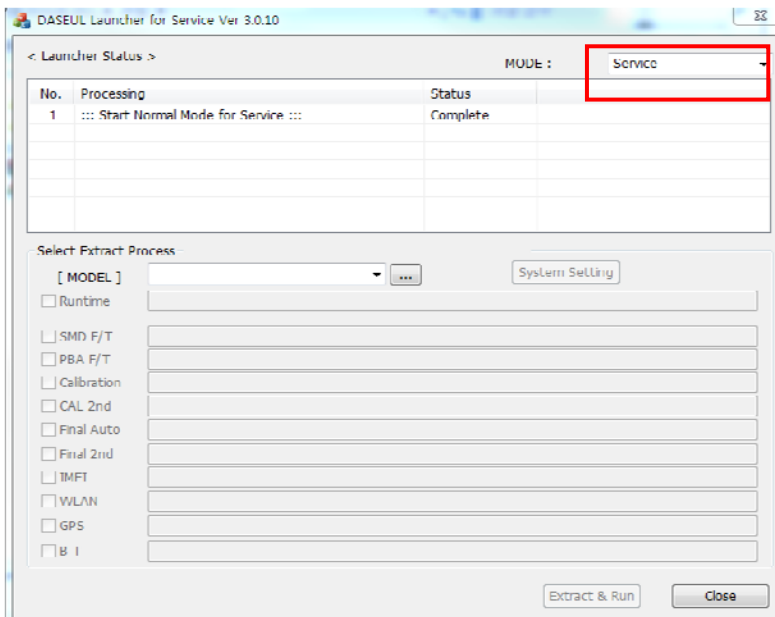

3. Click and Select folder where the Launcher exists

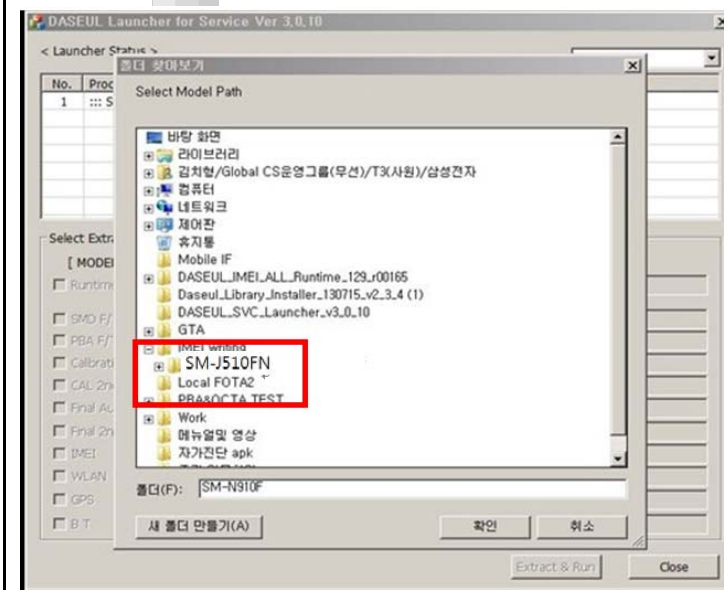

6. Level 1 Repair

4. Select Model

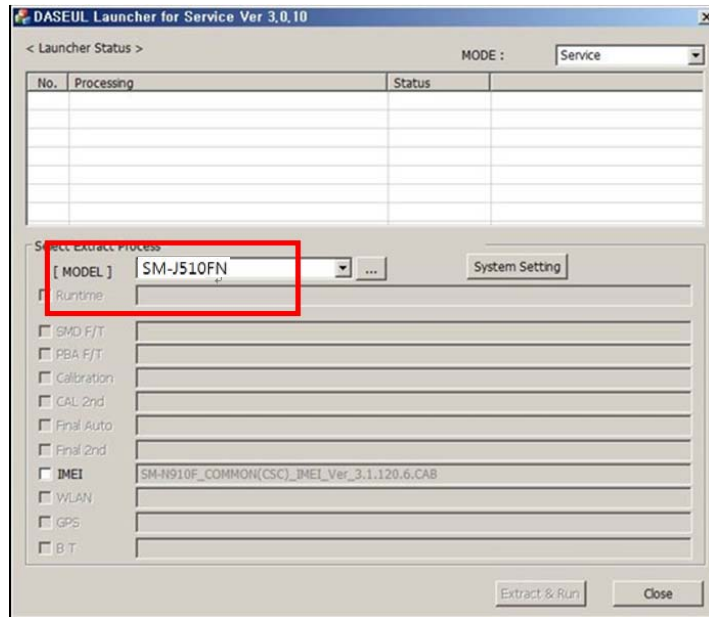

5. Check IMEI and click 'System Setting'

※Once you setup the setting, you don't have to do it again, unless there is change. From second run of the IMEI program, check IMEI and click 'Extract & Run'.

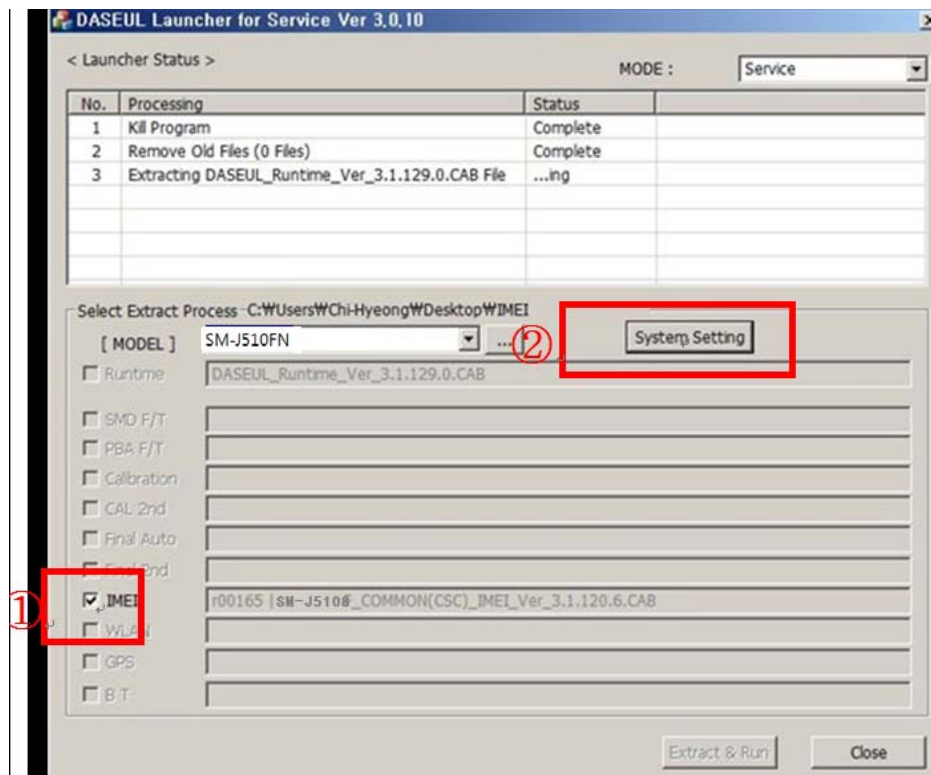

6. Level 1 Repair

6. Check 'IMEI Write / IMEI Check', and click 'IMEI SVC & Repair Option'

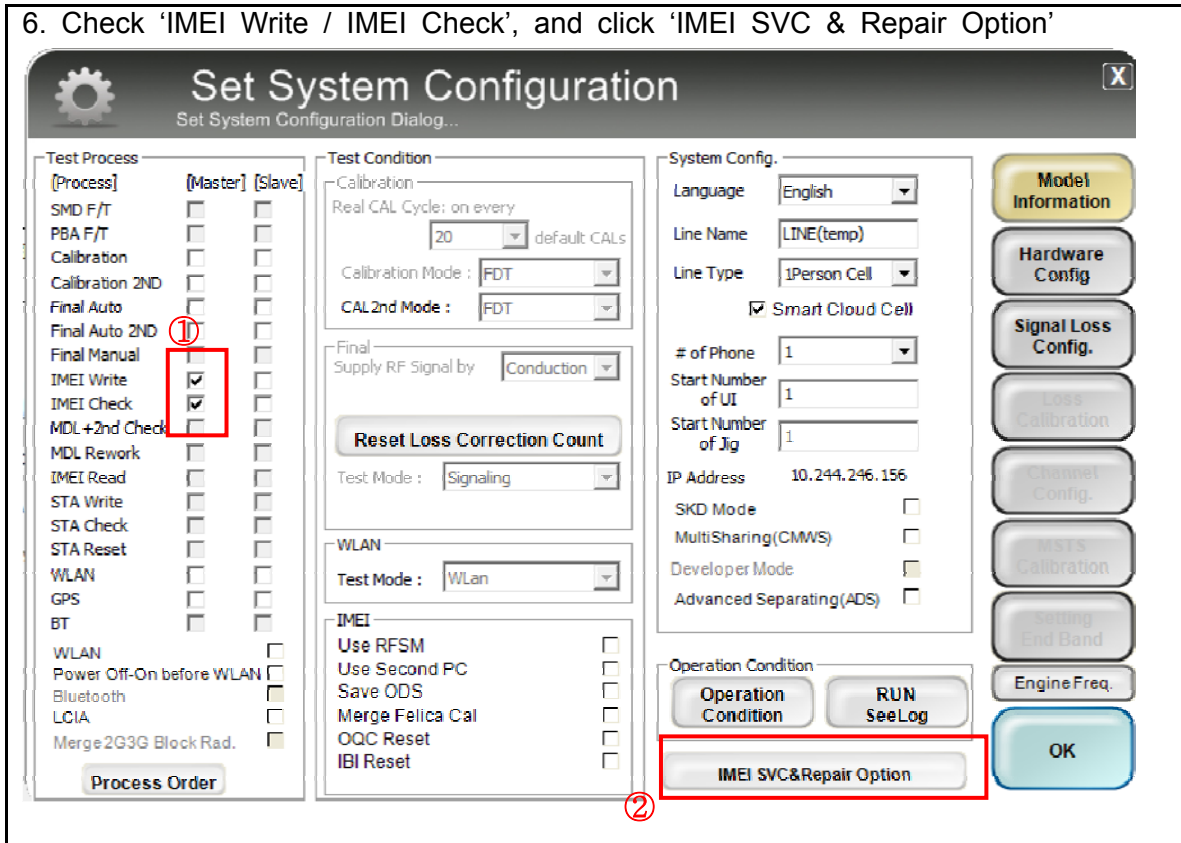

Set System Configuration
Set System Configuration Dialog...

Test Process

[Process]	(Master)	(Slave)
SMD F/T	<input type="checkbox"/>	<input type="checkbox"/>
PBA F/T	<input type="checkbox"/>	<input type="checkbox"/>
Calibration	<input type="checkbox"/>	<input type="checkbox"/>
Calibration 2ND	<input type="checkbox"/>	<input type="checkbox"/>
Final Auto	<input type="checkbox"/>	<input type="checkbox"/>
Final Auto 2ND	<input checked="" type="checkbox"/>	<input type="checkbox"/>
Final Manual	<input type="checkbox"/>	<input type="checkbox"/>
IMEI Write	<input checked="" type="checkbox"/>	<input type="checkbox"/>
IMEI Check	<input checked="" type="checkbox"/>	<input type="checkbox"/>
MDL+2nd Check	<input type="checkbox"/>	<input type="checkbox"/>
MDL Rework	<input type="checkbox"/>	<input type="checkbox"/>
IMEI Read	<input type="checkbox"/>	<input type="checkbox"/>
STA Write	<input type="checkbox"/>	<input type="checkbox"/>
STA Check	<input type="checkbox"/>	<input type="checkbox"/>
STA Reset	<input type="checkbox"/>	<input type="checkbox"/>
WLAN	<input type="checkbox"/>	<input type="checkbox"/>
GPS	<input type="checkbox"/>	<input type="checkbox"/>
BT	<input type="checkbox"/>	<input type="checkbox"/>
WLAN	<input type="checkbox"/>	<input type="checkbox"/>
Power Off-On before WLAN	<input type="checkbox"/>	<input type="checkbox"/>
Bluetooth	<input type="checkbox"/>	<input type="checkbox"/>
LCIA	<input type="checkbox"/>	<input type="checkbox"/>
Merge 2G3G Block Rad.	<input type="checkbox"/>	<input type="checkbox"/>

Test Condition

Calibration
Real CAL Cycle: on every
20 default: CALs
Calibration Mode: FDT
CAL2nd Mode: FDT

Final
Supply RF Signal by: Conduction
Reset Loss Correction Count
Test Mode: Signaling

WLAN
Test Mode: WLAN

IMEI
Use RFSM
Use Second PC
Save ODS
Merge Felica Cal
OQC Reset
IBI Reset

System Config.

Language: English
Line Name: LINE(temp)
Line Type: 1Person Cell
 Smart Cloud Cell
of Phone: 1
Start Number of UI: 1
Start Number of Jig: 1
IP Address: 10.244.246.156
SKD Mode
MultiSharing(CMWS)
Developer Mode
Advanced Separating(ADS)

Operation Condition
Operation Condition
RUN SeeLog
IMEI SVC&Repair Option

Model Information
Hardware Config
Signal Loss Config.
Loss Calibration
Channel Config.
MSTs Calibration
Setting End Band
Engine Freq.
OK

7. Check 'SVC , User Ticket No' and click OK

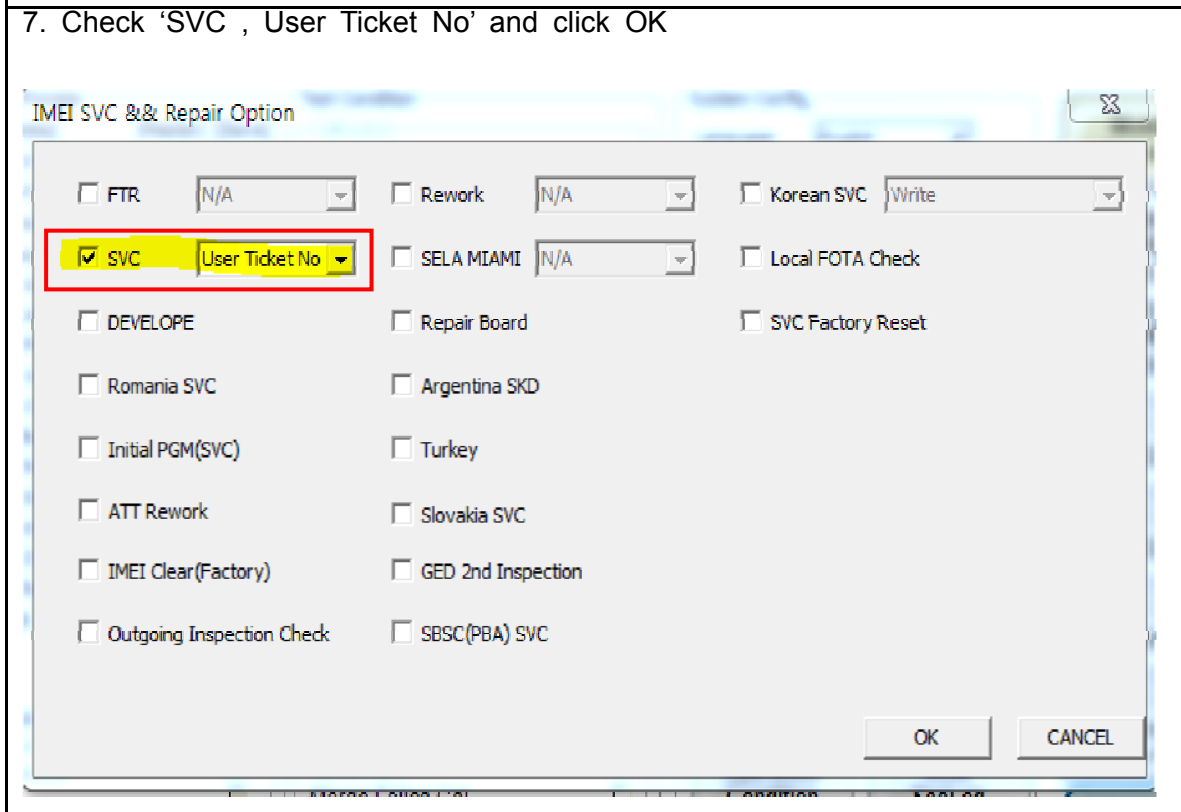

IMEI SVC & Repair Option

FTR N/A Rework N/A Korean SVC Write
 SVC User Ticket No SELA MIAMI N/A Local FOTA Check
 DEVELOPE Repair Board SVC Factory Reset
 Romania SVC Argentina SKD
 Initial PGM(SVC) Turkey
 ATT Rework Slovakia SVC
 IMEI Clear(Factory) GED 2nd Inspection
 Outgoing Inspection Check SBSC(PBA) SVC

OK CANCEL

6. Level 1 Repair

8. Click 'Hardware Config'

Set System Configuration
Set System Configuration Dialog...

Test Process

[Process]	[Master]	[Slave]
SMD F/T	<input type="checkbox"/>	<input type="checkbox"/>
PBA F/T	<input type="checkbox"/>	<input type="checkbox"/>
Calibration	<input type="checkbox"/>	<input type="checkbox"/>
Calibration 2ND	<input type="checkbox"/>	<input type="checkbox"/>
Final Auto	<input type="checkbox"/>	<input type="checkbox"/>
Final Auto 2ND	<input type="checkbox"/>	<input type="checkbox"/>
Final Manual	<input type="checkbox"/>	<input type="checkbox"/>
IMEI Write	<input checked="" type="checkbox"/>	<input type="checkbox"/>
IMEI Check	<input checked="" type="checkbox"/>	<input type="checkbox"/>
SVC Board	<input type="checkbox"/>	<input type="checkbox"/>
MDL Rework	<input type="checkbox"/>	<input type="checkbox"/>
IMEI Read	<input type="checkbox"/>	<input type="checkbox"/>
STA Write	<input type="checkbox"/>	<input type="checkbox"/>
STA Check	<input type="checkbox"/>	<input type="checkbox"/>
STA Reset	<input type="checkbox"/>	<input type="checkbox"/>
WLAN	<input type="checkbox"/>	<input type="checkbox"/>
GPS	<input type="checkbox"/>	<input type="checkbox"/>
BT	<input type="checkbox"/>	<input type="checkbox"/>
WLAN	<input type="checkbox"/>	<input type="checkbox"/>
Power Off-On before WLAN	<input type="checkbox"/>	<input type="checkbox"/>
Bluetooth	<input type="checkbox"/>	<input type="checkbox"/>
LCIA	<input type="checkbox"/>	<input type="checkbox"/>
Merge 2G3G Block Rad.	<input type="checkbox"/>	<input type="checkbox"/>

Test Condition

Calibration
Real CAL Cycle: on every default: CALs

Calibration Mode :

CAL2nd Mode :

Final
Supply RF Signal by :

Reset Loss Correction Count

Test Mode :

WLAN
Test Mode :

IMEI
Use RFSM
Use Second PC
Save ODS
Merge Felica Cal
OQC Reset
IBI Reset

System Config.

Language :

Line Name :

Line Type :

Smart Cloud Cell

of Phone :

Start Number of UT :

Start Number of Jig :

IP Address : 10.244.246.165

SKD Mode

MultiSharing(CMWS)

Developer Mode

Advanced Separating(ADS)

Operation Condition

9. Click 'Port Setting'

Hardware Component Configuration
Controller Type, IO Bus Type, Port Setting,...

Phone

Count :

I/F - 1 Type :

I/F - 2 Type :

I/F Jig Type :

Use ID Check JIG

MSTS Sharing Controller

Count :

Control Type :

I/F Type :

Robot / ShieldBox

Control Type :

I/F Type :

Power Supply

I/F Type :

DBMS

Server :

Type :

Barcode Reader

Type :

I/F Type :

MES PN Sender

Type :

SMD F/T

Type :

B'd Address :

6. Level 1 Repair

10. Select Port Number and SAVE

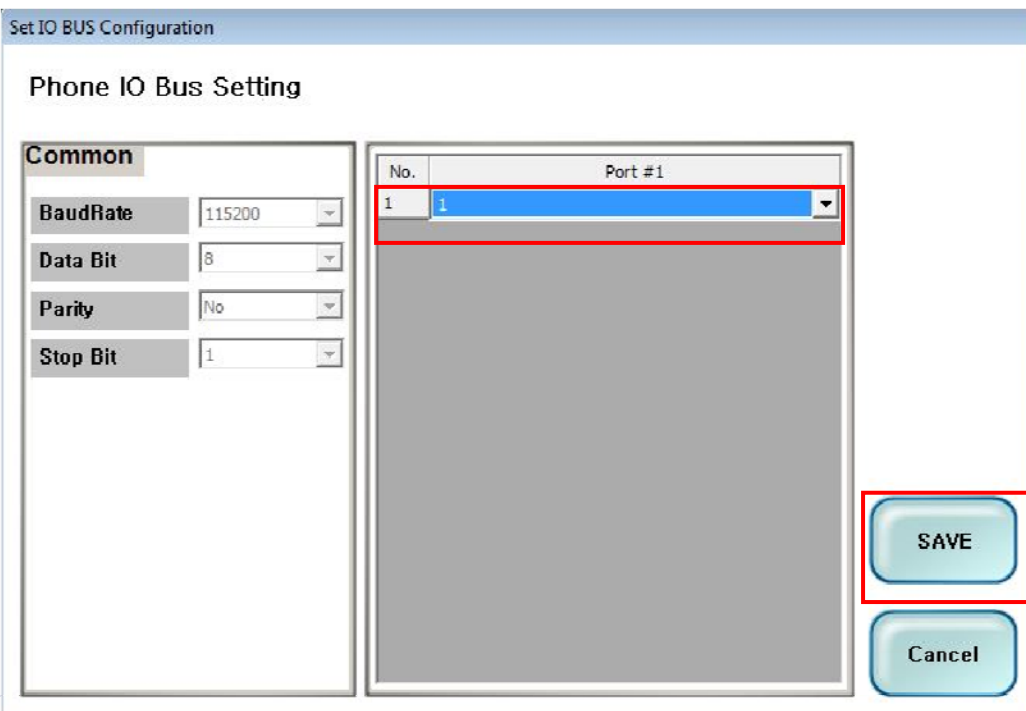

Set IO BUS Configuration

Phone IO Bus Setting

Common

BaudRate: 115200
 Data Bit: 8
 Parity: No
 Stop Bit: 1

No.	Port #1
1	1

SAVE
 Cancel

11. Click OK to proceed

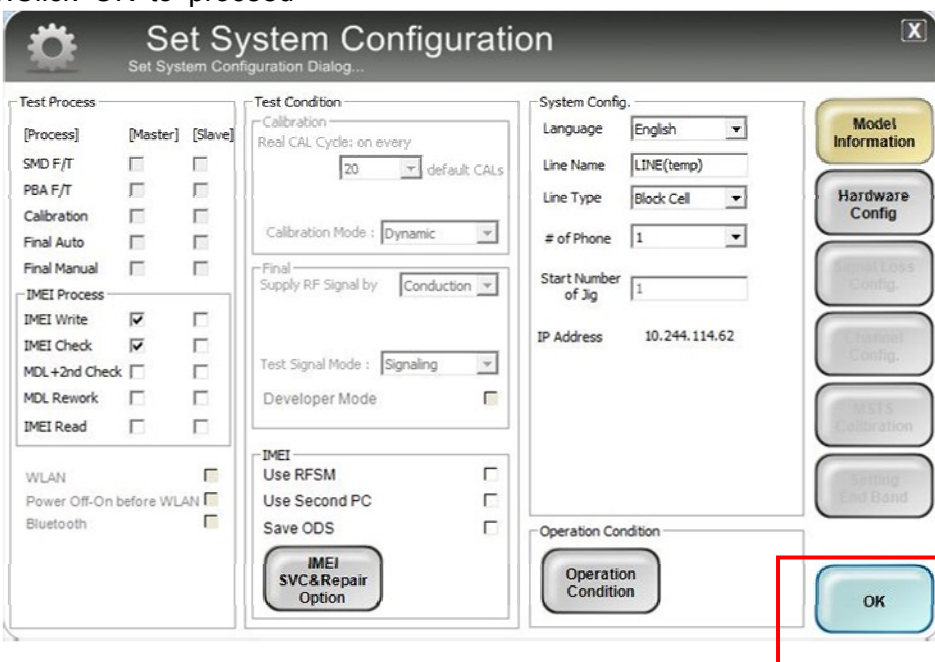

Set System Configuration
 Set System Configuration Dialog...

Test Process

[Process] [Master] [Slave]

SMD F/T
 PBA F/T
 Calibration
 Final Auto
 Final Manual

IMEI Process

IMEI Write
 IMEI Check
 MDL+2nd Check
 MDL Rework
 IMEI Read

WLAN
 Power Off-On before WLAN
 Bluetooth

Test Condition

Calibration
 Real CAL Cycle: on every
 20 default CALs
 Calibration Mode: Dynamic

Final
 Supply RF Signal by: Conduction

Test Signal Mode: Signaling
 Developer Mode

IMEI
 Use RFSM
 Use Second PC
 Save ODS

IMEI SVC&Repair Option

System Config.

Language: English
 Line Name: LINE(temp)
 Line Type: Block Cell
 # of Phone: 1
 Start Number of Jig: 1
 IP Address: 10.244.114.62

Operation Condition
 Operation Condition

Model Information
 Hardware Config
 Signal Loss Config
 Channel Config.
 IMEI Calibration
 Setting End Band

OK

12. Click Model Info and OK when pop-up shows

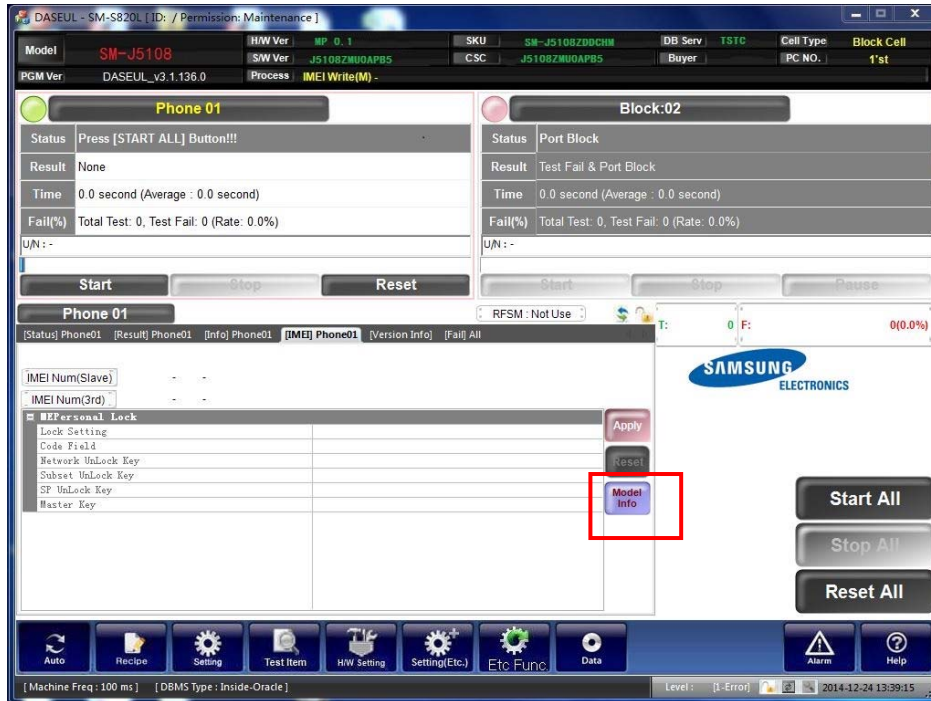

13. Click OK



6. Level 1 Repair

14. Input SKU_CODE, then click OK button.

※ Refer to HHPsvc→IMEI Review to check SKU Code and buyer

MEID Model Information

H/W Ver1: MP 0.1
H/W Ver2:

Use Test Label

	Version
BOOT	<input type="text"/>
PDA	J5108ZMU0APB3
PHONE	J5108ZMU0APB3
Memory	<input type="text"/>
Hidden	<input type="text"/>
CSC	J5108ZMU0APB3
Cam1	V13QLIA00SA
Cam1-1	V13QLIA00SA
S_Cam1	D05QLIA00CA
S_Cam1-1	<input type="text"/>
Touch1	N
Touch1-1	<input type="text"/>
E-Write1	<input type="text"/>
E-Write1-1	<input type="text"/>
TSP 1	IM001005
TSP 1-1	IM001003
TSP2	<input type="text"/>
TSP2-1	<input type="text"/>
Spare1	<input type="text"/>
Spare2	<input type="text"/>
OIS1	<input type="text"/>
OIS1-1	<input type="text"/>

Item Code: **SM-J5108ZZDCHM**
 MES

Basic Model Code:

SIM SKU:

Sensor Hub:

Comp. Engine Version:

Contents Version:

Factory Binary Option

Factory - PDA Version: FA51-J5108ZMU0APE3
Factory - Phone Version: J5108ZMU0APB3

Factory Reset + Check Pre Product

MDL Rework

SMD Test NV Write Main Repair

STA Option

RF Pass Count: 15
XML LOG Path:
Material Code:
 Don't Upload DB

PRL/ERI

PRL Version:
PRL File Name:
ERI Version:
ERI File Name:

OK Cancel

6. Level 1 Repair

15. Input IMEI Number and click Apply

DASEUL - SM-N910F

Model	SM-N910F	HW Ver	MP_0.1	SKU	SM-J510BZDUURIM	DB Serv	TSTC	Cell Type	Block Cell
PGM Ver	DASEUL_v3.1.136.0	Process	IMEI Write(M)	CSG	J510BZMU0APB5	Buyer		PC NO.	1st

Phone 01 ID Check

Status: Please Exit & Restart The Program.

Result: None

Time: 0.0 second (Average : 0.0 second)

Fail(%): Total Test: 0, Test Fail: 0 (Rate: 0.0%)

UN: -

Phone 01

[Status] Phone01 [Result] Phone01 [Info] Phone01 [IMEI] Phone01 [Version Info] [Fail] All

IMEI Num: 111111 - 11 - 111111

IMEI Num(Slave): - - -

IMEI Num(3rd): - - -

SN Num: -

ME Personal Lock

Lock Setting

Code Field

Network UnLock Key

Subset UnLock Key

SP UnLock Key

Master Key

Apply

Reset

Model Info

Start

Stop

Reset

Auto

Recipe

Setting

Test Item

HW Setting

Setting(Etc.)

Etc Func

Data

Alarm

Help

[One Step] : [Machine Freq : 100 ms] [DBMS Type : Outside-WebSVC] Level: [I-Error] 2014-10-21 19:21:38

16. Click Start ALL

DASEUL - SM-S820L [ID: / Permission: Maintenance]

Model	SM-J510B	HW Ver	MP_0.1	SKU	SM-J510BZDDCHM	DB Serv	TSTC	Cell Type	Block Cell
PGM Ver	DASEUL_v3.1.136.0	Process	IMEI Write(M)	CSG	J510BZMU0APB5	Buyer		PC NO.	1st

Phone 01

Status: Press [START ALL] Button!!!

Result: None

Time: 0.0 second (Average : 0.0 second)

Fail(%): Total Test: 0, Test Fail: 0 (Rate: 0.0%)

UN: -

Start

Stop

Reset

Block:02

Status: Port Block

Result: Test Fail & Port Block

Time: 0.0 second (Average : 0.0 second)

Fail(%): Total Test: 0, Test Fail: 0 (Rate: 0.0%)

UN: -

Start

Stop

Pause

Phone 01

[Status] Phone01 [Result] Phone01 [Info] Phone01 [IMEI] Phone01 [Version Info] [Fail] All

IMEI Num(Slave): - - -

IMEI Num(3rd): - - -

ME Personal Lock

Lock Setting

Code Field

Network UnLock Key

Subset UnLock Key

SP UnLock Key

Master Key

Apply

Reset

Model Info

Start All

Stop All

Reset All

Auto

Recipe

Setting

Test Item

HW Setting

Setting(Etc.)

Etc Func

Data

Alarm

Help

[Machine Freq : 100 ms] [DBMS Type : Inside-Oracle] Level: [I-Error] 2014-12-24 13:39:15

6. Level 1 Repair

17. Connect the phone to Anyway JIG

✘ When you connect the phone, the phone should be turned off.

After connecting the phone, the phone will be booted automatically.

18. IMEI Writing Proceeding

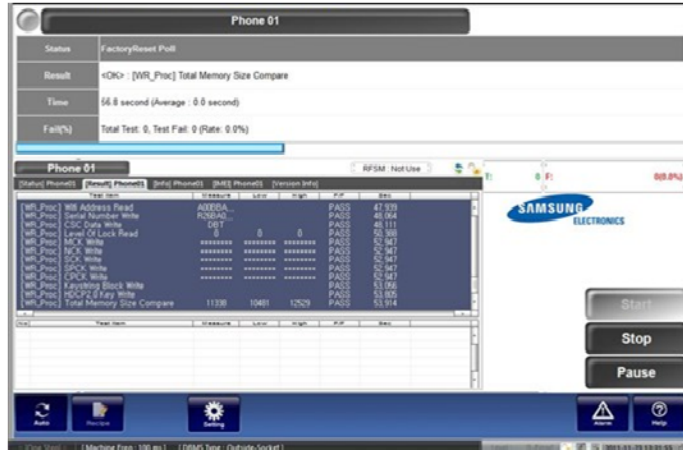

19. IMEI Writing Success

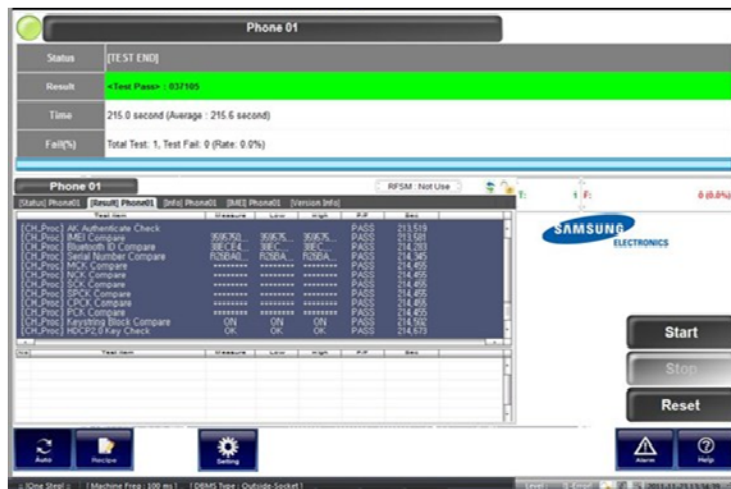

6. Level 1 Repair

6-3. RF Calibration

6-3-1. Required items in order to calibrate RF







- Installation program: RF Calibration Program

- Daseul_Launcher_vx.x.xx.exe
- Daseul_CAL_ALL_Runtime_x.x.xxx.x.CAB
- Model File ([SM-J510FN_OPEN_CALIBRATION_Ver_3.1.131.0.CAB](#))

※ It is required to use the latest program.

- [SM-J510FN](#) Mobile Phone
- R&S CMW500
- E3632A Power Supply
- JIG BOX (GH81-11888A)
- Adapter (GH81-11888K)
- GPIB Cable (2ea)
- IF Cable (GH81-10952A)
- UART Serial Cable
- 1.35Φ RF Cable (GH81-11962G 1ea)

- Table of test cables

IF Cable	GH81-10631A	GH81-10952A	GH81-11171A	
	11 pin	7 pin (New)	7 pin (Old)	
RF Cable (Manual)	GH81-11962D	GH81-11962G	GH81-11962C	GH81-11962F
	1.35T, Short 	1.35T, Long 	1.6T, Short 	1.6T, Long 
4 Port Divider	GH81-11962A	GH81-11962B	GH81-11962E	
	Use / No use 	Divider Cable 	50Ω terminator 	

6. Level 1 Repair

✧ Setting

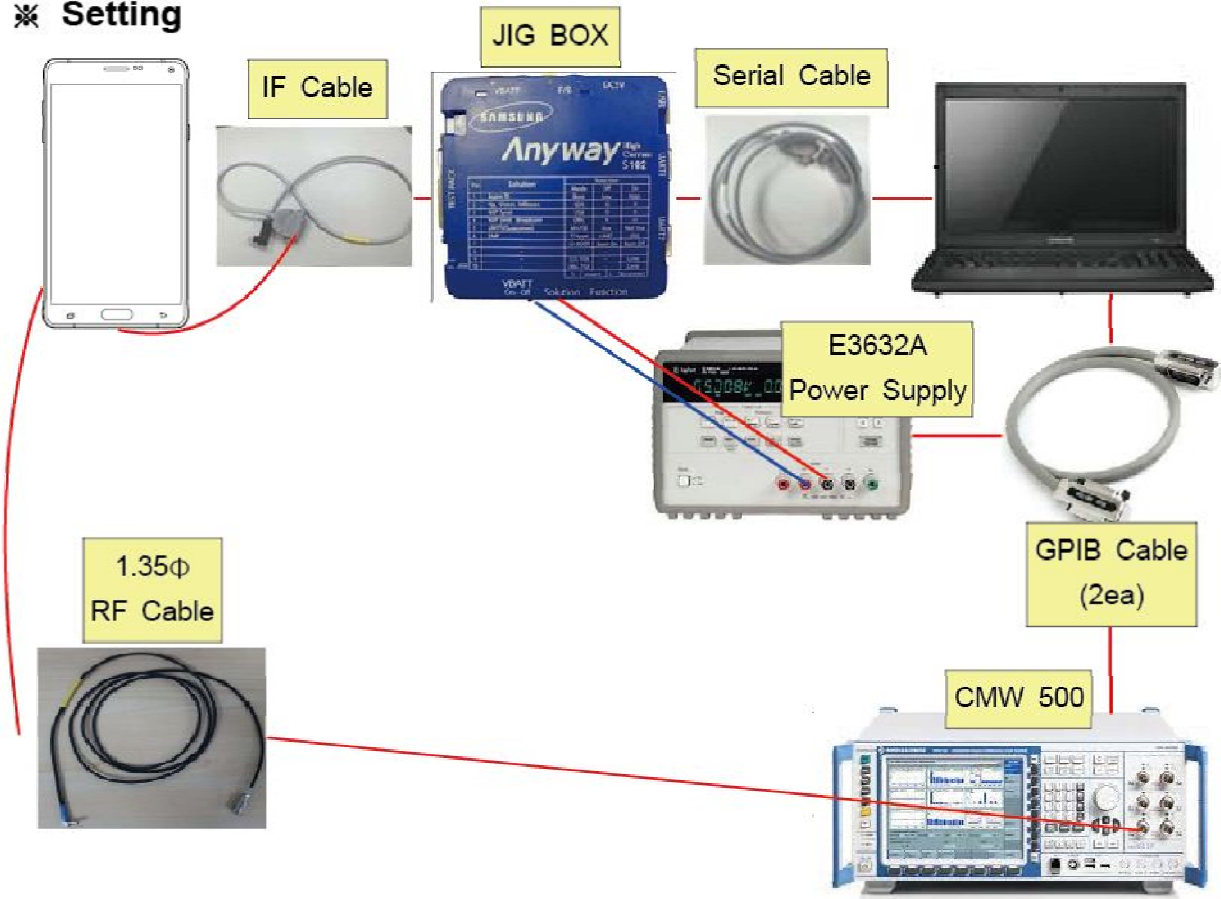

6. Level 1 Repair

6-3-2. RF Calibration Program

1. Run the RF Calibration Program Launcher, 'DASEUL_Launcher_vx.x.xx.exe'.

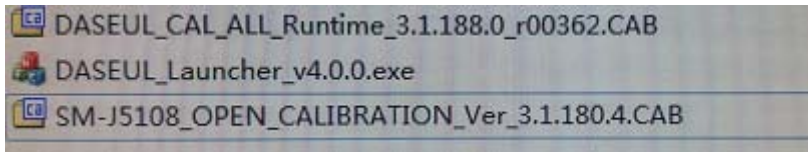

2. Check the 'Calibration' menu, and select 'Extract & Run'.

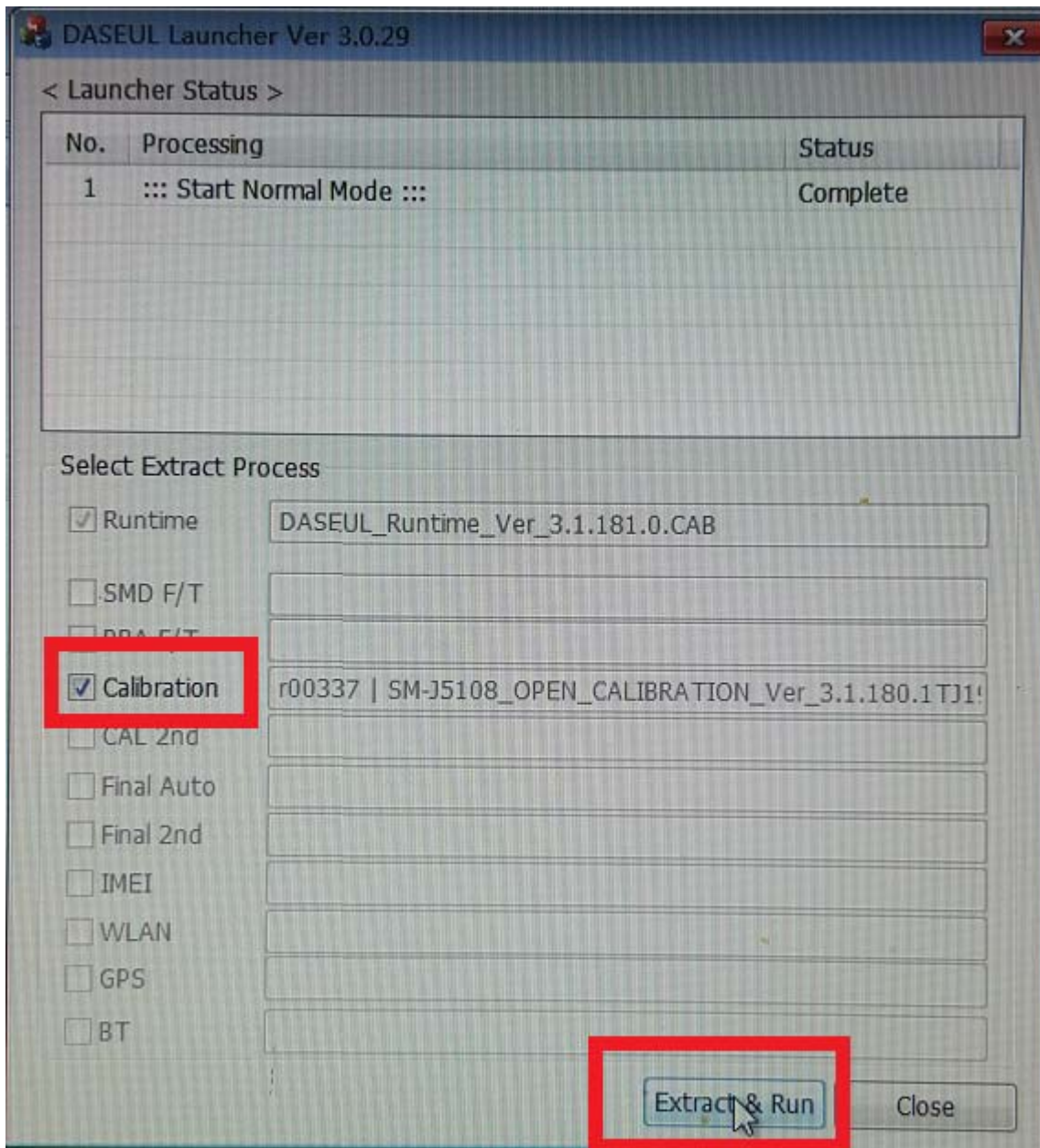

6. Level 1 Repair

3. Check the 'CAL' and open the [model file](#), then select 'Start' button.

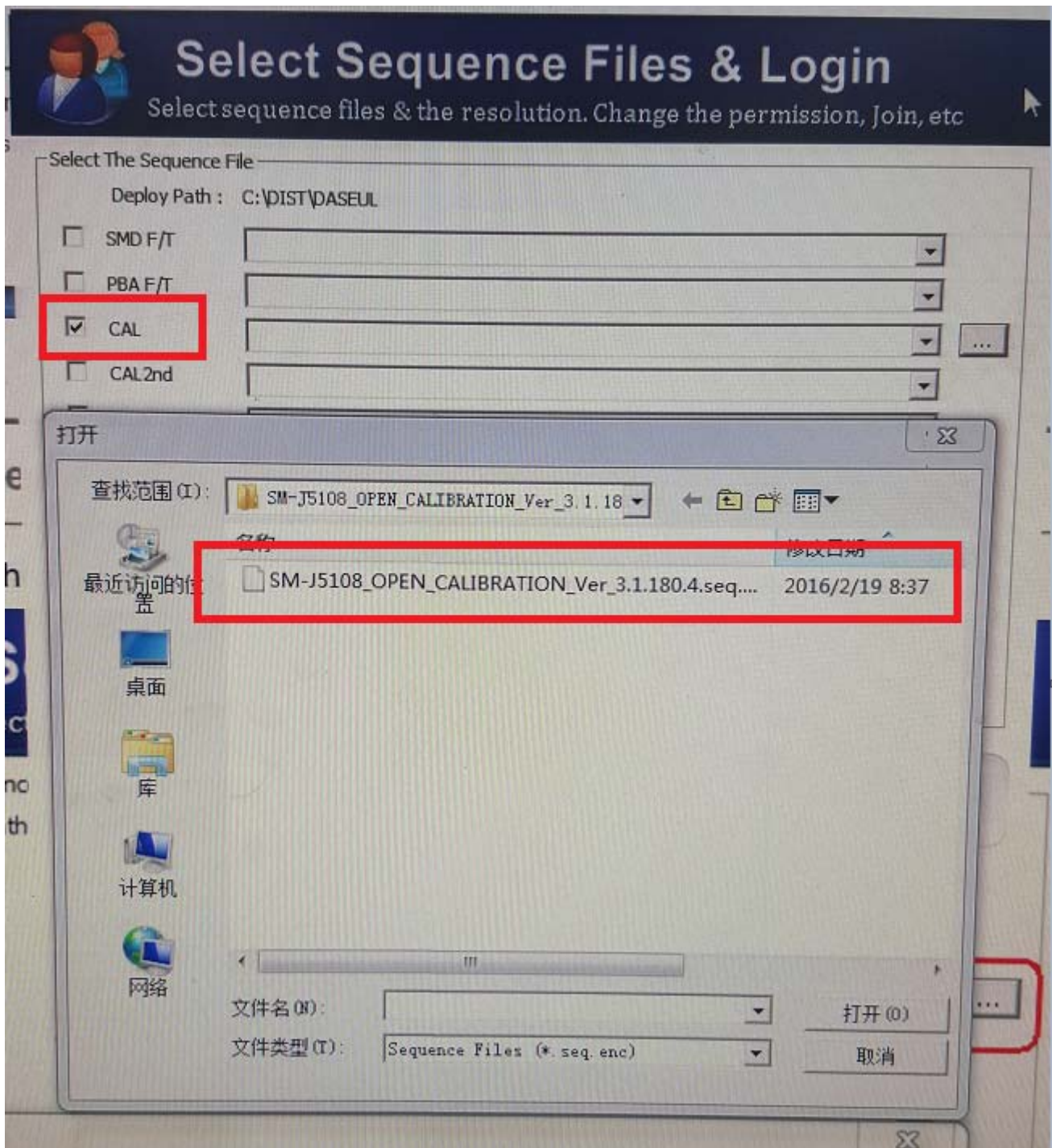

6. Level 1 Repair

4. Change the Line Type to 'Block Cell' and disable 'Smart Cloud Cell'.

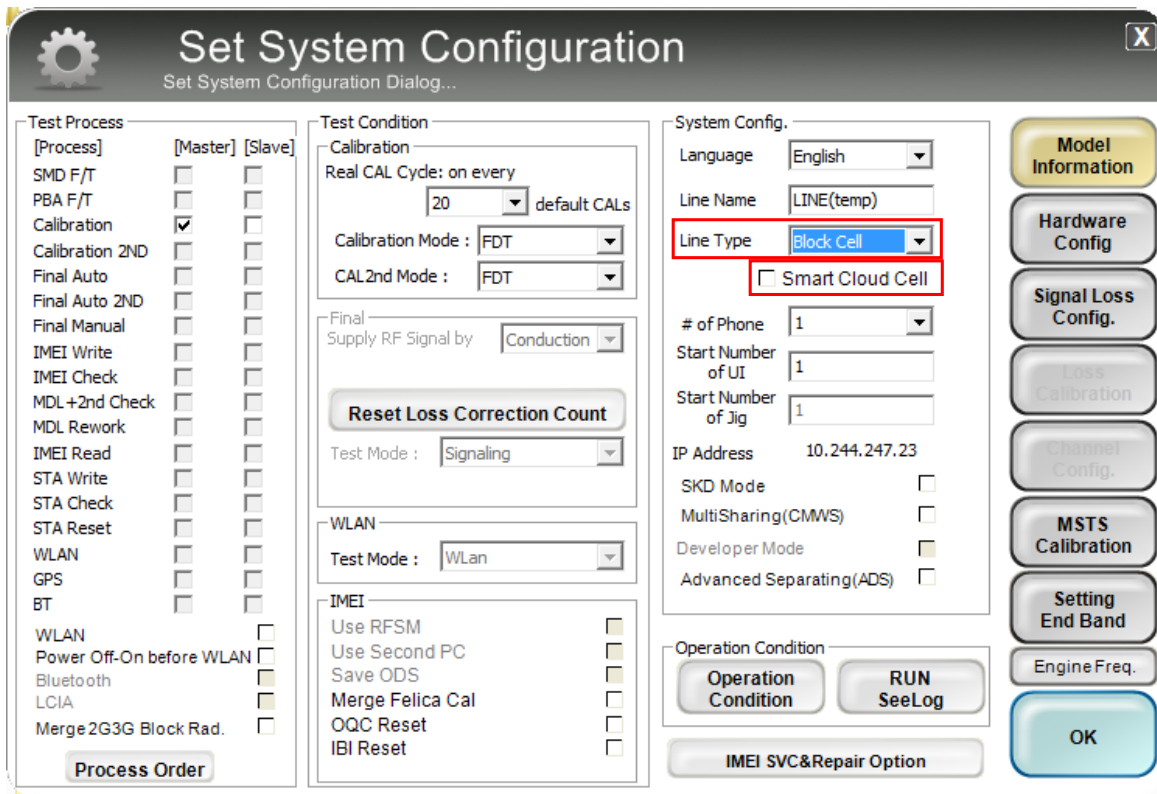

Set System Configuration
Set System Configuration Dialog...

Test Process	[Master]	[Slave]
[Process]		
SMD F/T	<input type="checkbox"/>	<input type="checkbox"/>
PBA F/T	<input type="checkbox"/>	<input type="checkbox"/>
Calibration	<input checked="" type="checkbox"/>	<input type="checkbox"/>
Calibration 2ND	<input type="checkbox"/>	<input type="checkbox"/>
Final Auto	<input type="checkbox"/>	<input type="checkbox"/>
Final Auto 2ND	<input type="checkbox"/>	<input type="checkbox"/>
Final Manual	<input type="checkbox"/>	<input type="checkbox"/>
IMEI Write	<input type="checkbox"/>	<input type="checkbox"/>
IMEI Check	<input type="checkbox"/>	<input type="checkbox"/>
MDL +2nd Check	<input type="checkbox"/>	<input type="checkbox"/>
MDL Rework	<input type="checkbox"/>	<input type="checkbox"/>
IMEI Read	<input type="checkbox"/>	<input type="checkbox"/>
STA Write	<input type="checkbox"/>	<input type="checkbox"/>
STA Check	<input type="checkbox"/>	<input type="checkbox"/>
STA Reset	<input type="checkbox"/>	<input type="checkbox"/>
WLAN	<input type="checkbox"/>	<input type="checkbox"/>
GPS	<input type="checkbox"/>	<input type="checkbox"/>
BT	<input type="checkbox"/>	<input type="checkbox"/>
WLAN	<input type="checkbox"/>	<input type="checkbox"/>
Power Off-On before WLAN	<input type="checkbox"/>	<input type="checkbox"/>
Bluetooth	<input type="checkbox"/>	<input type="checkbox"/>
LCIA	<input type="checkbox"/>	<input type="checkbox"/>
Merge 2G3G Block Rad.	<input type="checkbox"/>	<input type="checkbox"/>

Test Condition

Calibration
Real CAL Cycle: on every 20 default CALs

Calibration Mode : FDT
CAL2nd Mode : FDT

Final
Supply RF Signal by : Conduction

Reset Loss Correction Count

Test Mode : Signaling

WLAN
Test Mode : WLAN

IMEI
Use RFSM
Use Second PC
Save ODS
Merge Felica Cal
OQC Reset
IBI Reset

System Config.

Language : English
Line Name : LINE(temp)
Line Type : Block Cell
 Smart Cloud Cell
of Phone : 1
Start Number of UI : 1
Start Number of Jig : 1
IP Address : 10.244.247.23
SKD Mode
MultiSharing(CMWS)
Developer Mode
Advanced Separating(ADS)

Operation Condition
Operation Condition
IMEI SVC&Repair Option

Model Information
Hardware Config
Signal Loss Config.
Loss Calibration
Channel Config.
MSTS Calibration
Setting End Band
Engine Freq.
OK

Process Order

6. Level 1 Repair

- Set the GPIB address of MSTs(CMW500) and Power Supply(E3632A) to enter 'Hardware Config' and 'Save'. (Check the GPIB address of equipments in advance)

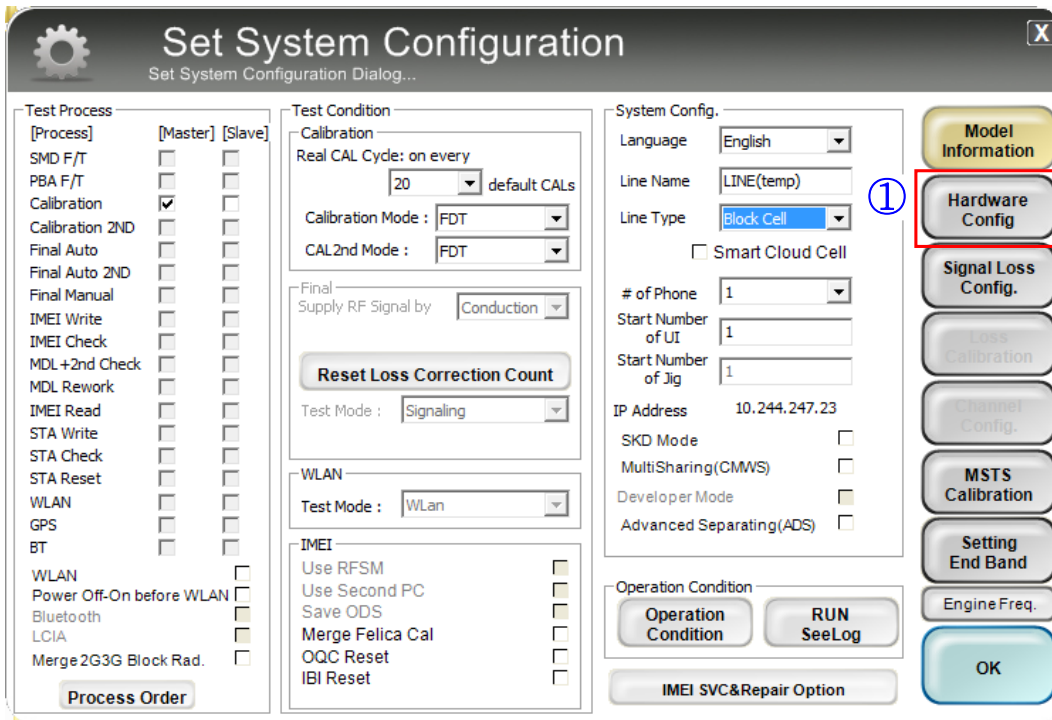

Set System Configuration
Set System Configuration Dialog...

Test Process

[Process]	[Master]	[Slave]
SMD F/T	<input type="checkbox"/>	<input type="checkbox"/>
PBA F/T	<input type="checkbox"/>	<input type="checkbox"/>
Calibration	<input checked="" type="checkbox"/>	<input type="checkbox"/>
Calibration 2ND	<input type="checkbox"/>	<input type="checkbox"/>
Final Auto	<input type="checkbox"/>	<input type="checkbox"/>
Final Auto 2ND	<input type="checkbox"/>	<input type="checkbox"/>
Final Manual	<input type="checkbox"/>	<input type="checkbox"/>
IMEI Write	<input type="checkbox"/>	<input type="checkbox"/>
IMEI Check	<input type="checkbox"/>	<input type="checkbox"/>
MDL +2nd Check	<input type="checkbox"/>	<input type="checkbox"/>
MDL Rework	<input type="checkbox"/>	<input type="checkbox"/>
IMEI Read	<input type="checkbox"/>	<input type="checkbox"/>
STA Write	<input type="checkbox"/>	<input type="checkbox"/>
STA Check	<input type="checkbox"/>	<input type="checkbox"/>
STA Reset	<input type="checkbox"/>	<input type="checkbox"/>
WLAN	<input type="checkbox"/>	<input type="checkbox"/>
GPS	<input type="checkbox"/>	<input type="checkbox"/>
BT	<input type="checkbox"/>	<input type="checkbox"/>
WLAN	<input type="checkbox"/>	<input type="checkbox"/>
Power Off-On before WLAN	<input type="checkbox"/>	<input type="checkbox"/>
Bluetooth	<input type="checkbox"/>	<input type="checkbox"/>
LCIA	<input type="checkbox"/>	<input type="checkbox"/>
Merge 2G3G Block Rad.	<input type="checkbox"/>	<input type="checkbox"/>

Test Condition

Calibration
Real CAL Cycle: on every default CALs

Calibration Mode :

CAL2nd Mode :

Final
Supply RF Signal by :

Reset Loss Correction Count

Test Mode :

WLAN

Test Mode :

IMEI

Use RFSM	<input type="checkbox"/>
Use Second PC	<input type="checkbox"/>
Save ODS	<input type="checkbox"/>
Merge Felica Cal	<input type="checkbox"/>
OQC Reset	<input type="checkbox"/>
IBI Reset	<input type="checkbox"/>

System Config.

Language :

Line Name :

Line Type :

Smart Cloud Cell

of Phone :

Start Number of UI :

Start Number of Jig :

IP Address : 10.244.247.23

SKD Mode

MultiSharing(CMWS)

Developer Mode

Advanced Separating(ADS)

Operation Condition

Model Information

(highlighted with red box and circled '1')

6. Level 1 Repair

Hardware Component Configuration

Controller Type, IO Bus Type, Port Setting,...

Phone Count: 1

I/F - 1 Type: Serial COM

I/F - 2 Type: N/A

IF Jig Type: AnyWayJig

Multi Jig Cable Type: UART Line

Use Portable ID Check JIG

MSTS Count: 1

I/F Type: GPIB

MSTS Sharing Controller Count: 0

Control Type: N/A

I/F Type: Serial COM

Terminal

Port Setting

Switch-Box Port Setting

Robot / ShieldBox Control Type: N/A

I/F Type: Serial COM

Port Setting

Power Supply

E3632A

I/F Type: GPIB

Port Setting

DBMS Server: HOME(GUMI)

PBA F/T Function

Port Setting

Set IO BUS Configuration

MSTS IO Bus Setting

Common

EOS: 0

EOT: 1

Time Out: 13

No.	Board	Address
1	0	NOT USE
2		
3		
4		
5		
6		
7		
8		
9		
10		
11		
12		
13		
14		

SAVE

Cancel

SAVE

Cancel

6. Level 1 Repair

6. Press 'OK' to start RF Calibration after completing all settings.

