

# New Product SVC Guide [ SM-J510FN ]

Rev 2.7

Instructor : jewon park  
([jewon7.park@samsung.com](mailto:jewon7.park@samsung.com))



# Notice

This guide is intended solely for the Samsung Electronics internal training and may contain trade secret, industrial technology or privileged and confidential information otherwise protected under applicable law including the Unfair Competition Prevention and Trade Secret Protection Act. Any unauthorized dissemination, distribution, copying or use of the information contained in this guide is strictly prohibited and subject to legal action.

All functionality, features, specifications and other product information provided in this document including, but not limited to, the benefits, design, pricing, components, performance, availability, and capabilities of the product are subject to change without notice or obligation. Samsung reserves the right to make changes to this guide and the product described herein, at anytime, without obligation on Samsung Electronics to provide notification of such change.

# Contents

1. Specification of SM-J510FN (Galaxy J5 LTE)
2. H/W
  - 2-1. Disassembly & Assembly
  - 2-2. Troubleshooting
  - 2-3. R/F Calibration
3. S/W
  - 3-1. S/W Download
  - 3-2. Key Features
4. SVC Technical Information



# Specification

Item	Spec.		
AP Chipset	Vendor	Cores	Speed
	Qualcomm	Quad-core	1.2 Ghz
Memory	RAM	Flash	
	2GB	16GB	
Display	Size	Resolution	Type
	5.2 inch	720 X 1280, HD	Super AMOLED
CAMERA	Resolution (Main/Front)	Auto Focus(Main)	Video (Main)
	13MP / 5MP	Phase detection	1080p @ 30fps
Network	2G/3G	LTE	
	Support	800/850/900/1800/2100/2600	Cat 4(50Mbps UL / 150Mbps DL)
Sensors	Accelerometer, Proximity, Grip, magnetic (view cover)		
Connectivity	Bluetooth 4.1, WIFI b/g/n, NFC, USB2.0		
Battery & GPS	3,100mAh	A-GPS & GLONASS	
Micro SD & OS	Up to 128GB	Android V6.0 (MM)	
Remarks	New Pocket Type : -	Water Resistance : -	

# Disassembly & Reassembly



# Disassembly & Reassembly

## Important management points

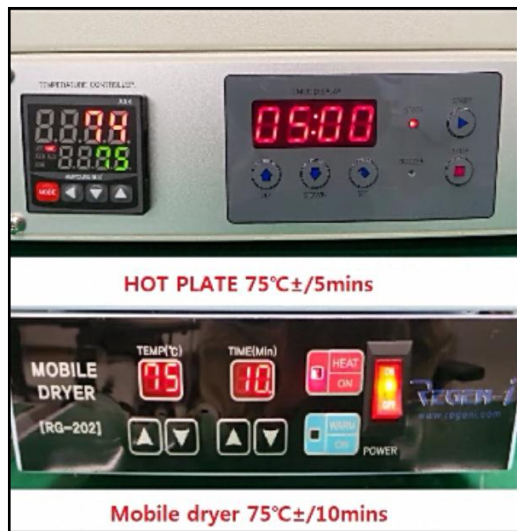

# Parts Layout

## Rear Case

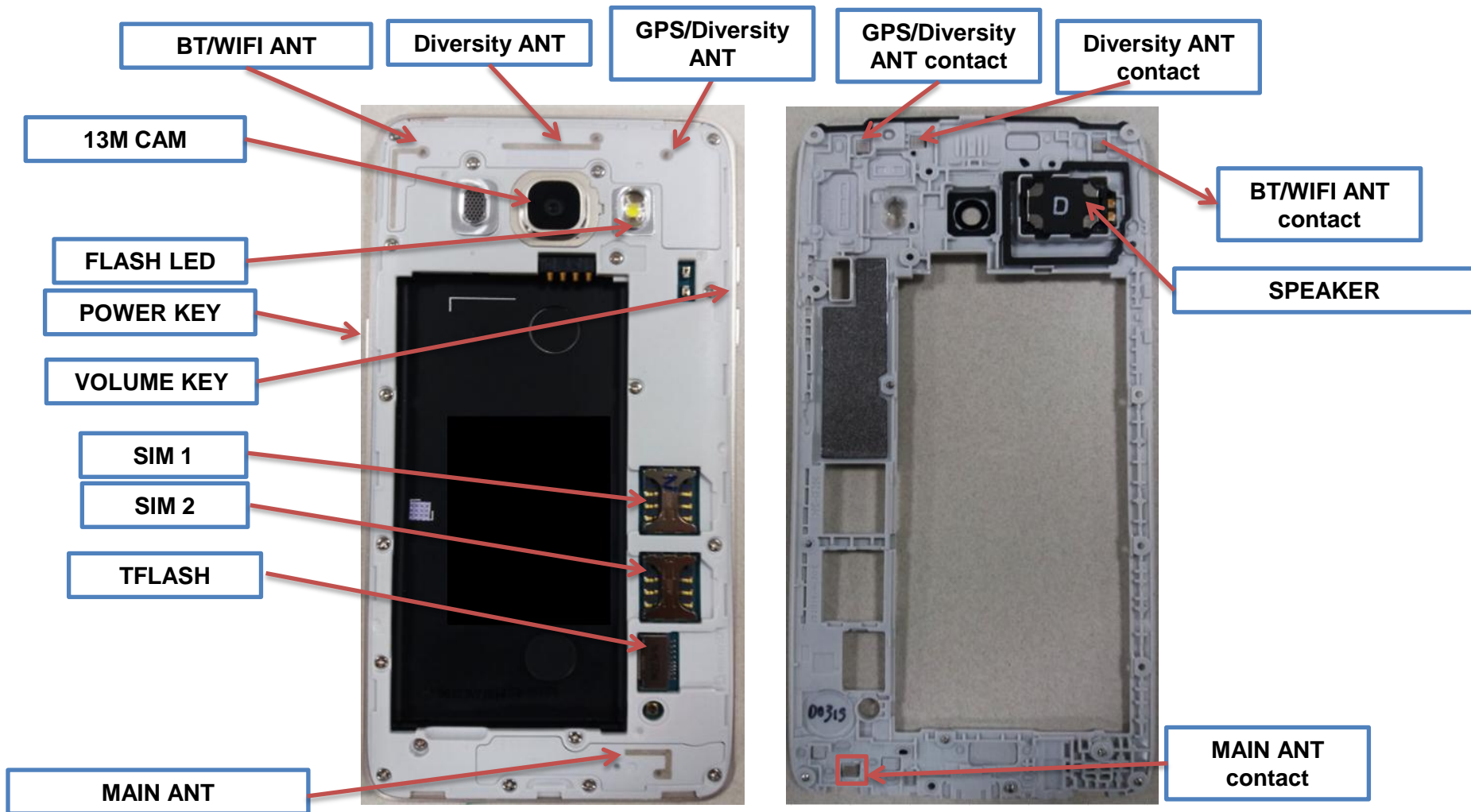

# Parts Layout

## PBA (Top side)

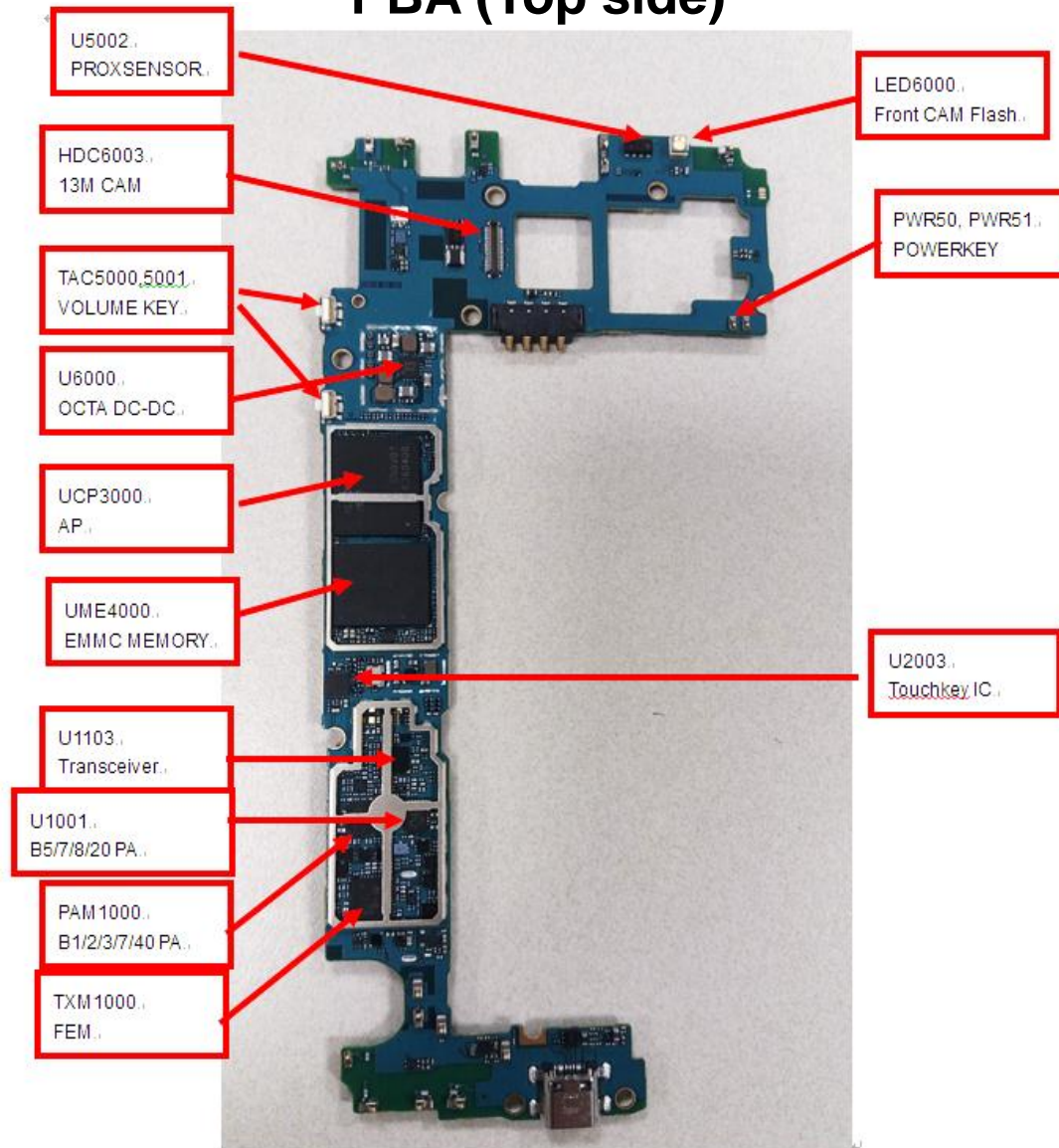



# Parts Layout

## PBA (Bottom side)

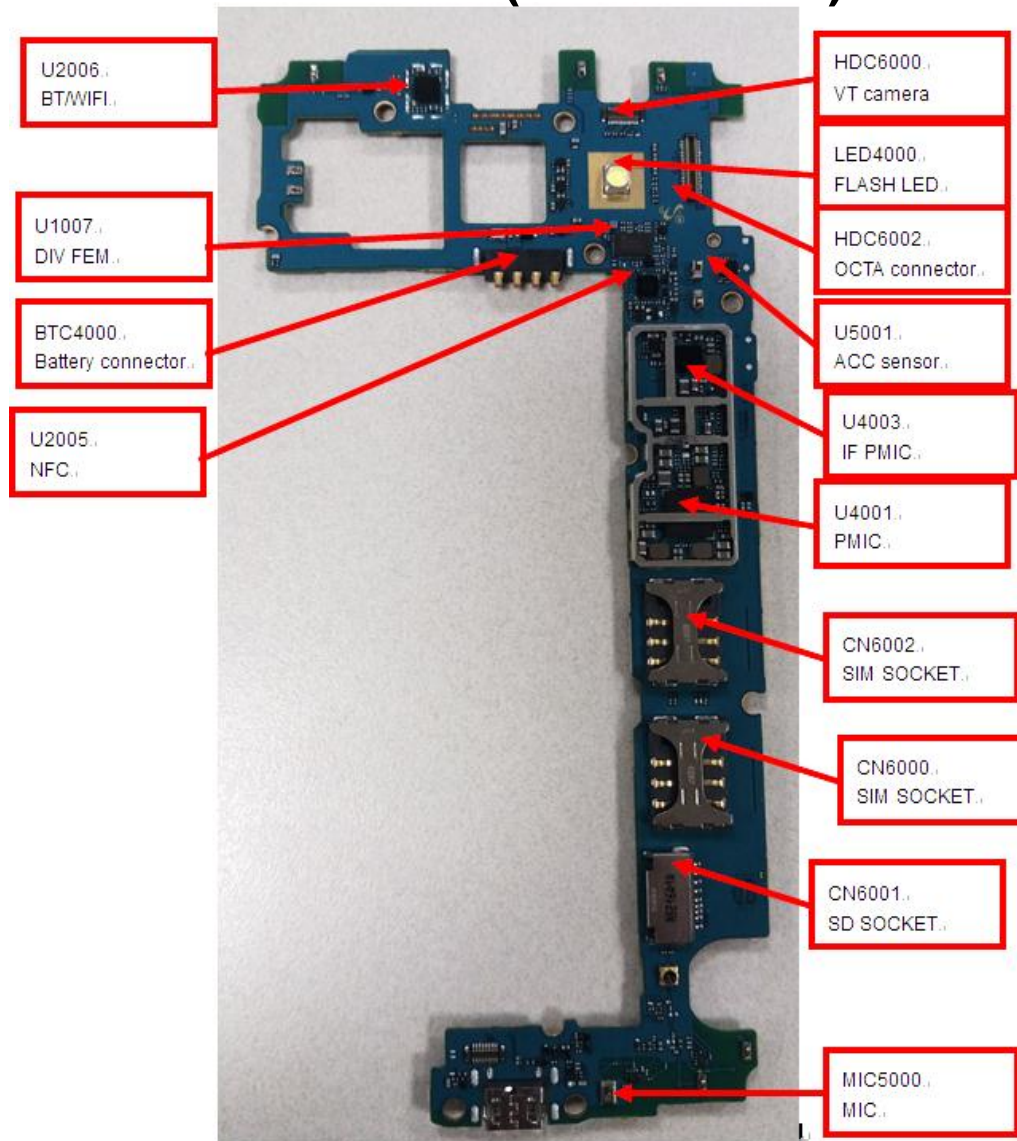

# Troubleshooting

## No Power

Step	Check point	Result value	Defect point
1	Confirm the defect symptom	-	-
2	** Analyse reasons of No-Power using the <b>Power &amp; Current test jig</b> <b>Power test mode</b> .	PASS	Battery, Battery terminal, Physical Key
		Leakage Current fail	Go to the step 2.1
2.1	Check the Resistance between JIG Power V_Battery / VPH_PWR/ V_BAT and Ground. (C4009,C4083)	Power On Current fail	Go to the step 3
		Normal (Over dozens of KΩ)	Go to the step 5
3	It's possible to enter the download mode?	Abnormal	Capacitors for ESD protection
		Yes	Go to the step 3.1
3.1	Check if it's rooted.	No	Go to the step4
		Rooted	OOW
4	Try to do the boot recovery.	Normal	S/W update
		Pass	Go to the step 3
5	Check the voltage of L4012	Fail	Go to the step 5
		L4012, L4009 = 5V	Go to the step 6
6	Check the voltage of C4035(=PMIC Output)	If not the correct value	Replace the U4003
		C4035 = 2.1V	Go to the step 7
		If not the correct value	Replace the U4001

\*\* Usage guide of the Power & Current test jig has been uploaded at GSPN. (Power & Current Tester\_Rev4\_141226.pdf)

# Troubleshooting

## No Power (cont')

Step	Check point	Result value	Defect point
7	Check the frequency of OSC4000	19.2MHz	Main chip (UCP3000-1)
		If not the correct value	X-TAL (OSC4000)

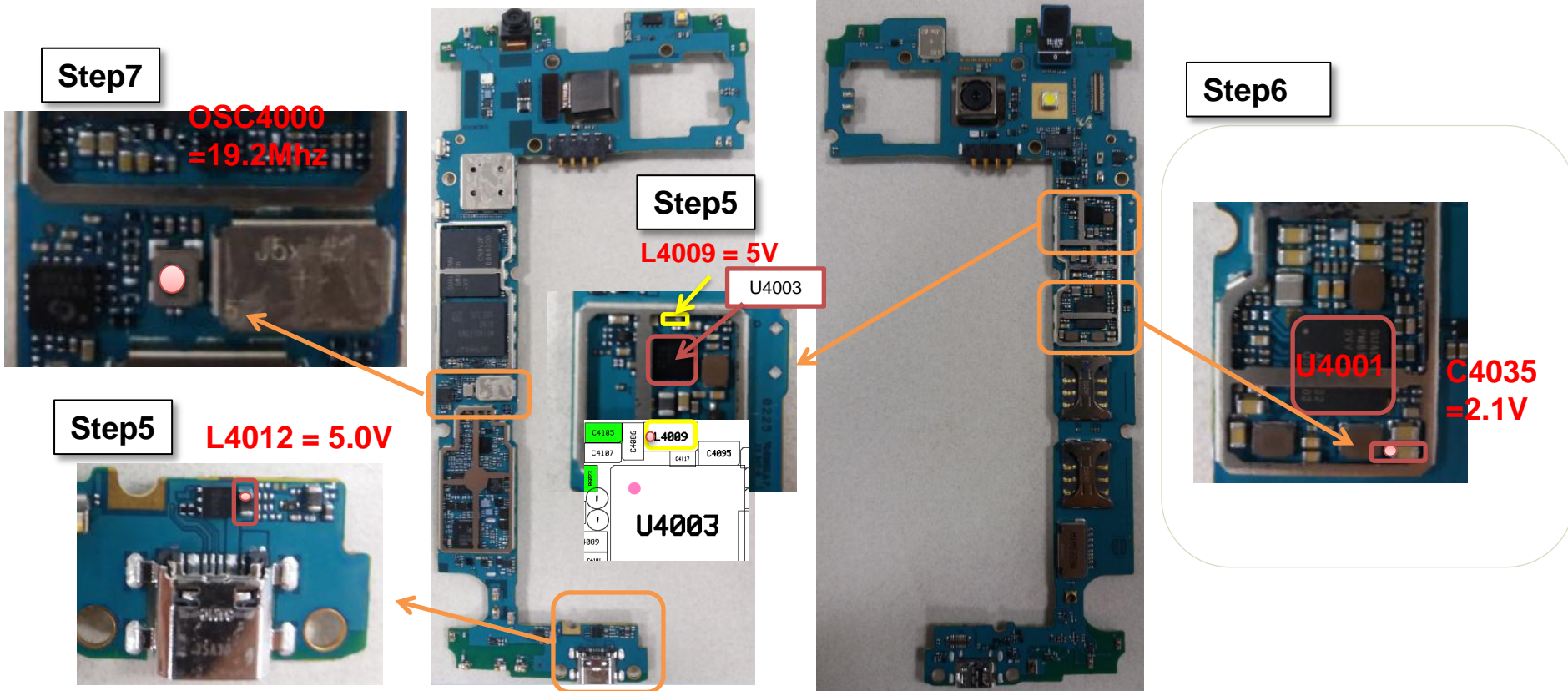

# Troubleshooting

## Power on but no operation (freezing)

Step	Check point	Result value	Defect point
1	Confirm the defect symptom	-	-
2	** Analyse reasons of No-Power using the <b>Power &amp; Current test jig</b> .	PASS	Go to the step 1
		Leakage Current fail	Refer to the No-power Troubleshooting
		Power On Current fail	Go to the step 2.1
2.1	Try to do the boot recovery.	Solved	Boot area in S/W
		Not solved	Go to the step 7
3	It's possible to enter the download mode?	Yes	Go to the step 3.1
		No	Go to the step 4
3.1	Check if it's rooted.	Rooted	OOW
		Normal	Go to the step 4
4	Enter the safe mode, and check if powers up.	Solved	3 <sup>rd</sup> party Apps.
		Not solved	Go to the step 5
5	Perform full reset.	Solved	S/W or 3 <sup>rd</sup> party Apps
		Not solved	Go to the step 6
6	Upgrade software to the latest version.	Solved	S/W
		Not solved	Go to the step 7
7	Check the voltage of C4052(eMMC)	C4052 = 1.8V	PBA
		If not the correct value	Replace the eMCP(eMMC)

\*\* Usage guide of the Power & Current test jig has been uploaded at GSPN. (Power & Current Tester\_Rev4\_141226.pdf)

# Troubleshooting

## Power on but no operation (freezing)

Step 7



C4052=1.8V

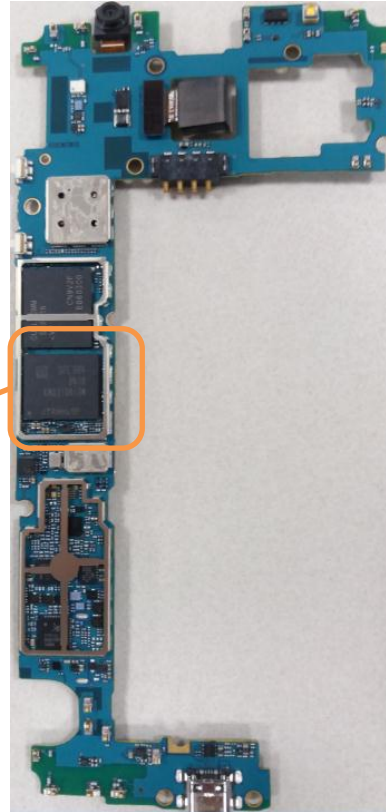

# Troubleshooting

## No Charging

Step	Check point	Result value	Defect point
1	Confirm the defect symptom	-	-
2	Replace a battery.	Solved	Go to the step 2.1
		Not solved	Go to the step 3
2.1	Charge the customer battery during 5min at least.	Solved	Totally discharged battery
		Not solved	Battery
3	** Analyse reasons of No-Charging using the <b>Power &amp; Current test jig Charging test mode</b> with no defect charger. (Test battery voltage should be below 85%)	PASS	Go to the step 4
		FAIL	Go to the step 5
4	** Test a <b>customer's charger</b> using the <b>Power &amp; Current test jig TA test mode</b> .	PASS	Go to the step 1
		FAIL	Customer's Charger
5	Disassemble and check I/F connector visually	Dust	Clean I/F connector
		Damage	Replace I/F connector
		Normal	Go to the step 6
6	Check the voltage of C4086	C4086 = 5V	Go to the step 7
		If not the correct value	may not connected charger
7	Check the voltage of L4009	L4009, L4012 = 5V	Replace the U4003
		If not the correct value	Replace the L4009, L4012

\*\* Usage guide of the Power & Current test jig has been uploaded at GSPN. (Power & Current Tester\_Rev4\_141226.pdf)

# Troubleshooting

## No Charging

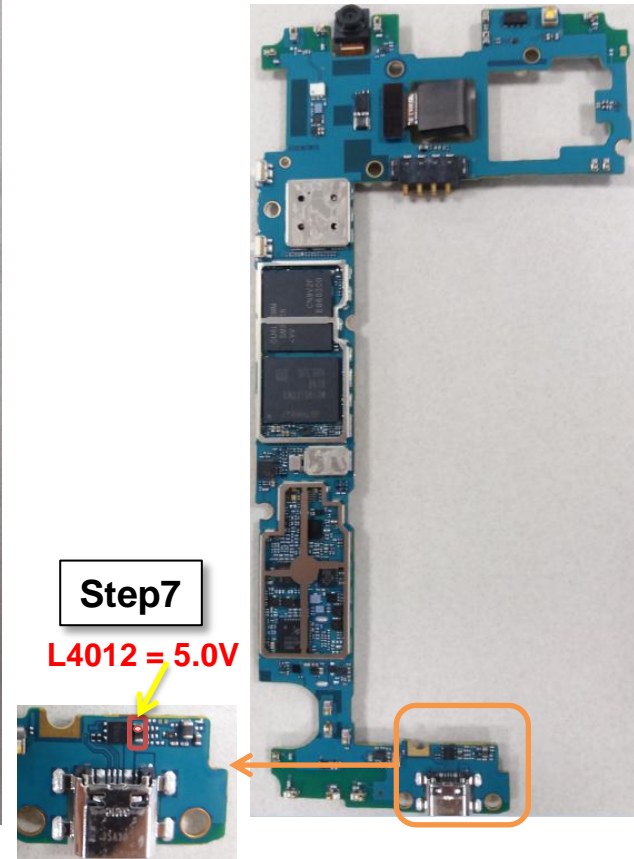
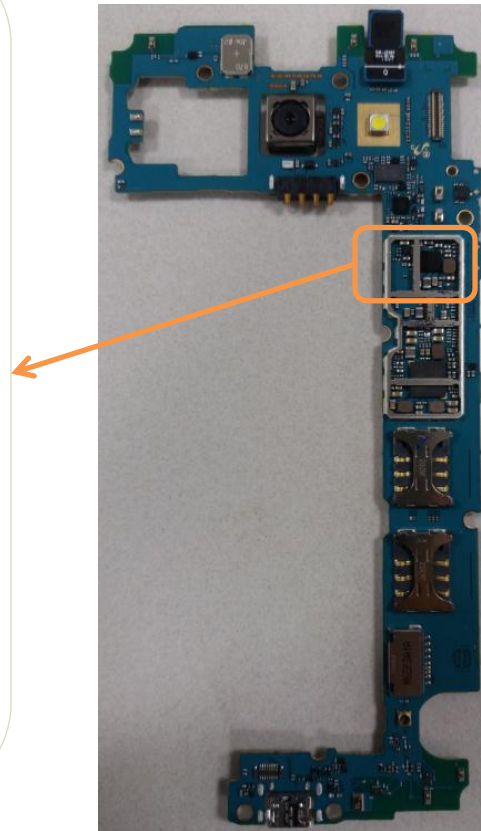
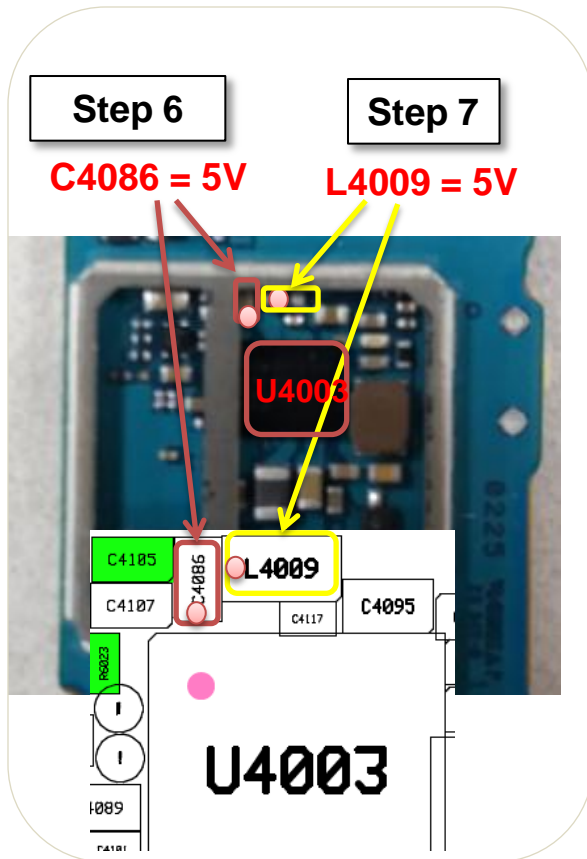

# Troubleshooting

## Call Problem (with RF equipment)

Step	Check point	Result value		Defect point
1	Confirm the defect symptom	-		-
2	RF radiation test	Pass		Network or Settings
		Fail		Go to the next step
3	RF calibration	Pass		Go to the step 4
		Fail		Go to the step 5
4	RF radiation test	Pass		Repaired
		Fail		Except PBA (Coaxial cable, Antenna, Shielding condition)
5	A type of failure  LB PAM(U1001) TRANSCEIVER(U1103) TXMODULE(TXM1000) MB/HB PAM(PAM1000) LFEM(U1007) FILTER(F1007: B1) FILTER(F1009: B3, DCS) FILTER(F1004: B40) FILTER(F1006: B7) FILTER(F1008: B2, PCS) FILTER(F1002: B5, GSM850) FILTER(F1001: B8, GSM900) FILTER(F1000: B20)	TX	2G	LB PAM,TRANSCEIVER, TXMODULE, FILTERs
			3G	MB/HB PAM,TRANSCEIVER, TXMODULE, FILTERs
			LTE	MB/HB PAM,TRANSCEIVER, TXMODULE, FILTERs
		RX	2G	TXMODULE, TRANSCEIVER, LFEM, FILTERs
			3G	TXMODULE, TRANSCEIVER, LFEM, FILTERs
			LTE	TXMODULE, TRANSCEIVER, LFEM, FILTERs



# Troubleshooting

## Call Problem

**Step5**

U1103 (Transceiver)

U1007 (LFEM)

PAM1000

U1001 (LB PAM)

TXM1000

F1008, F1009  
F1007, F1006  
F1002, F1001  
F1000

The image shows a troubleshooting guide for a call problem. It features a central photograph of a phone's internal PCB with several components highlighted by red boxes. A green arrow points from a group of filter components (F1000-F1009) to the TXM1000 component. To the left of the photograph is a detailed component map of the filter area, and to the right is a larger component map of the entire PCB. The component maps show the locations of U1103, PAM1000, U1001, TXM1000, and various filter components (F1000-F1009). A circular callout labeled 'BH410' is also present in the right map.

# Troubleshooting

## Call Problem (without RF equipment)

Step	Check point	Result value	Defect point
1	Confirm the defect symptom	-	-
2	Check the settings (airplane mode, Mobile networks)	Abnormal	Settings
		Normal	Go to the next step
3	Check the debug screen *#0011# (Compare to normal device)	Abnormal	Go to the next step
		Normal	Network
4	Check the RF parts except PBA. (Antenna, Shielding condition, etc..)	Broken, dust, corrosion	RF parts
		Loose fitting	Connection
		Normal	Go to the next step
5	Check the status visually(crack, missing, Corrosion..etc) of RF components. (compare to normal PBA) TRANSCEIVER(U1103) TXMODULE(TXM1000) LB PAM(U1001) MB/HB PAM(PAM1000) APT MODULATOR(U1004)	Abnormal	RF components.
		Normal	CP(Call Processor) (UCP3000-1) CP PMIC(U4001)

# Troubleshooting

## Call Problem

### Step2,3

CHECK SETTINGS

Wireless and networks

Airplane mode

ServiceMode  
RRC : IDLE, Band1  
MCC-MNC : 450 - 08  
RX: 10763, RI: -60, CID: 1a0c2  
TX: 9813\_PSC: 283  
Eclo: -5, RSCP: -65  
SpeechVER : FR FR FR  
L1 : PCH\_Sleep  
Drx cycle: 128  
SIB19 is received

DEBUG SCREEN STATUS  
Same value compare to  
normal device.

### Step4

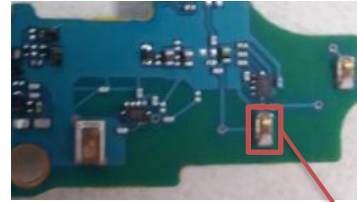

Main  
ANTENNA contact



ANT. Contact (for main RF)

### Step5

### Step4

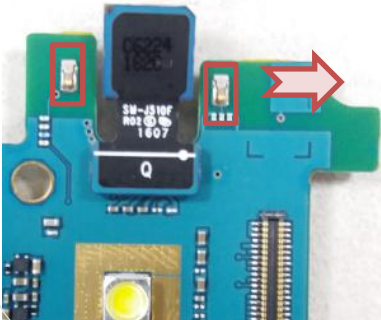

Diversity  
ANTENNA contact



U1103 (Transceiver)

PAM1000

U1001 (LB PAM)

TXM1000

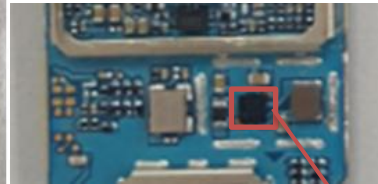
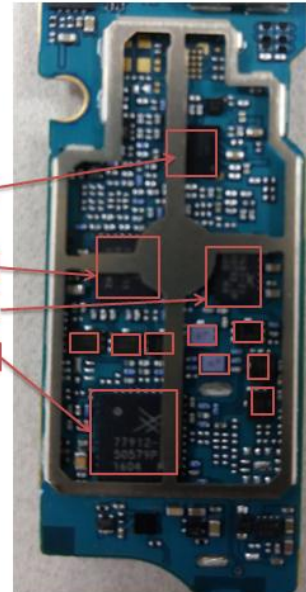

U1004  
(APT  
MODUL  
ATOR)



# Troubleshooting

## Sound Problem

Step.	Check point	Result value	Defect point
1	Confirm the defect symptom.	-	-
2	*#0*# → speaker	No sound	Go to the next step
		Normal	S/W or Settings
3	Replace the speaker, and also replace the Assy case-rear to use a new speaker tape.	Solved	speaker
		Not solved	Go to the next step
4	Activate the speaker path. (*#0*# → Speaker)	-	-
5	Check the signal at two of speaker contacts. (Using oscilloscope) Notice : It should be measured when the speaker path is activated on.	Same signal compared with a good PBA	Go to step 6
		No signal	Go to step 7
6	Check if the SPK is contacted to PBA well, and assemble the phone again.	Solved	Assembly error
		Not solved	Go to step 3
7	Check if the SPK is contacted to PBA well, and If yes, replace the PMIC.	Solved	PMIC
		Not solved	Go to step 3

# Troubleshooting

## Sound Problem

Step3

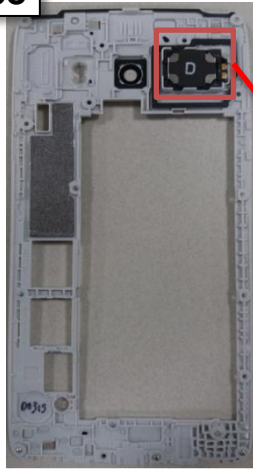

Assy case-rear

Speaker

Step6

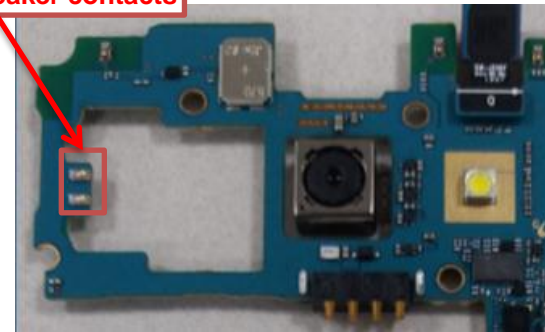

Assy PBA

Speaker contacts

Step7

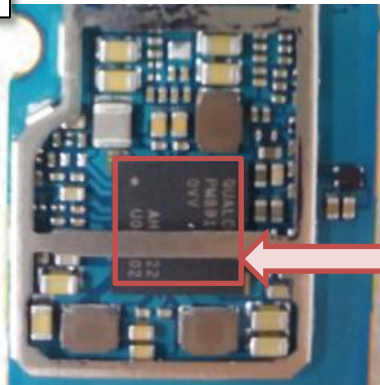

U4001  
PMIC

# Troubleshooting

## Display Problem

Step	Check point	Result value	Defect point
1	Confirm the defect symptom	-	-
2	Check the AMOLED connector (HDC6002)	Broken, dust, corrosion	AMOLED connector (HDC6002)
		Loose fitting	Connection
		Normal	Go to step 3
3	Replace the AMOLED	Solved	AMOLED
		Not solved	Go to step 4
4	Connect a AMOLED, and display on with a power supply (power supply voltage : 4.0V)	-	-
5	Check the voltage of C6039 = 3.0V Notice. It should be measured when the display is activated on	If not the correct value	LDO(U5006) (VDD_LCD_3P0)
		C6039=3.0V	Go to step 6
6	Check the voltage of C6038 = 1.8V Notice. It should be measured when the display is activated on	If not the correct value	LDO(U6004) (VDD_LCD_1P8)
		C6038=1.8V	Go to step 7
7	Check the voltage of following chips (C6051,C6052,C6050) Notice. It should be measured when the display is activated on	If not the correct value C6041 = +7.6V C6043 = 4.6V C6042 = -4.0V	OLED DC DC (U6000)

# Troubleshooting

## Display Problem

**Step2** LCD CONNECTOR: HDC6002

**Step5**

**U5006**  
(VDD\_LCD\_3P0)

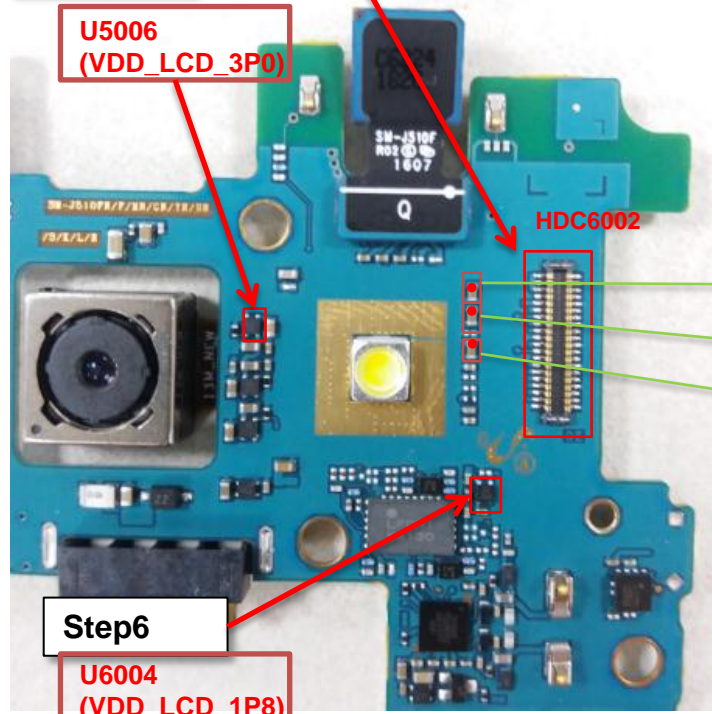

**Step7**

**OLED DC DC**  
(U6000)

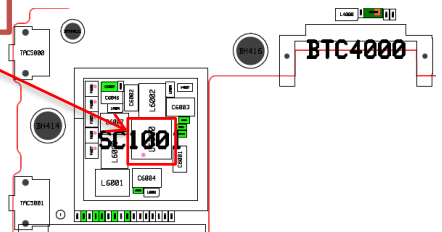
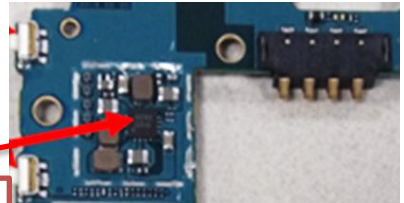

**Step6**  
**U6004**  
(VDD\_LCD\_1P8)

# RF Calibration Preparation

Item	Quantity	Code
① RF cable (Instrument to divider)	1	GH81-11962G
② Anyway JIG	1	-
③ Power Supply	1	E3632A
④ RF Equipment	1	CMW500
⑤ IF cable	1	GH81 – 10952A

Connection Diagram

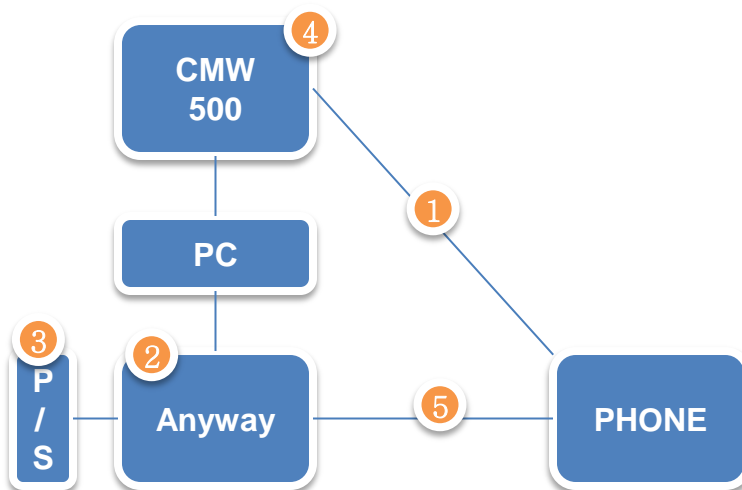



# S/W Download

## How to enter the S/W download mode

1. Turn off the device
2. Press 3 buttons simultaneously  
( Volume down + Home + Power on)
3. Press volume up button after 'Warning' message.
4. Connect the USB cable after 'Downloading' message.

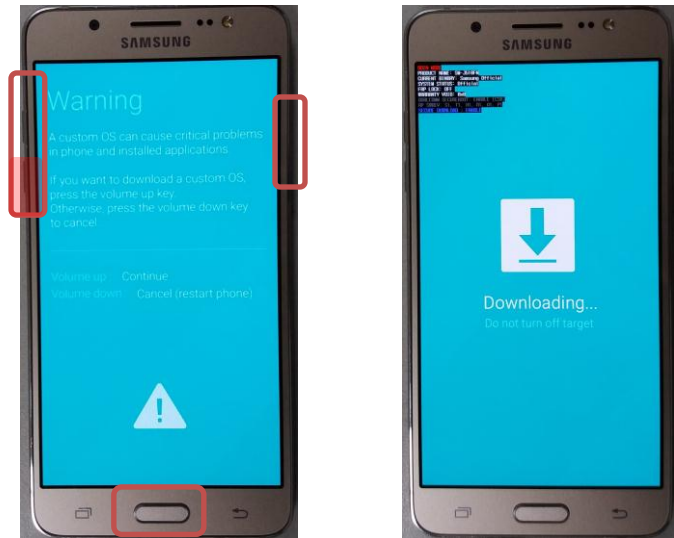

## How to download S/W

1. Run the Odin tool with 3.11+ and check the device is connected to Odin.
2. Select each 4 S/W files.  
(BL,AP,CP,CSC)
3. Press the start button in the Odin.
4. Automatically reboot the phone when the downloading is completed.

**Hard reset : press Volume Down+Power key during 7 sec.**

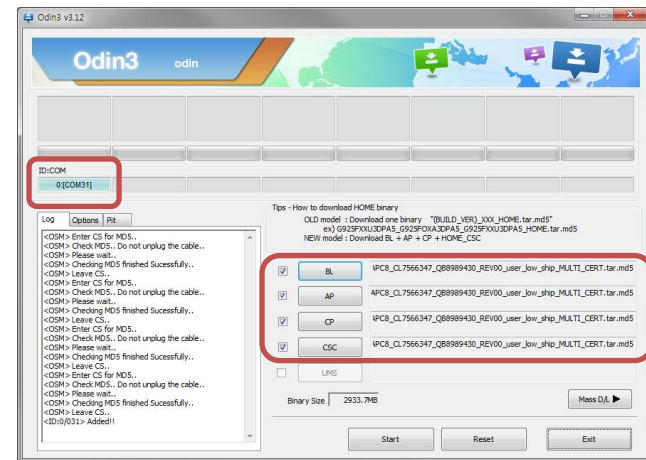

# Key Features

## Ultra power saving mode

No more need to worry



### Power Saving Mode (+Ultra Power Saving Mode) Enhancing power for important situations

Use the Power Saving Mode to save and extend your battery life so you no longer have to worry about missing important calls when your phone is running low on battery. In addition, the new Ultra Power Saving Mode changes your screen to black and white and shuts down all unnecessary features to dramatically minimize battery consumption.

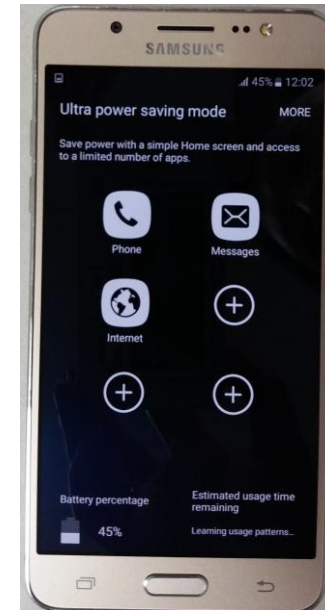

### Entering Path :

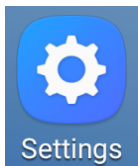

Battery

Ultra power saving mode  
Learning usage patterns...

**Settings → Battery → Ultra power saving mode**

# Key Features

## Camera

### Smarter 'Selfie' Functions

Enjoy Selfie with better quality and with more friend

#### Wide selfie

Perfect for group selfie & splendid scenery

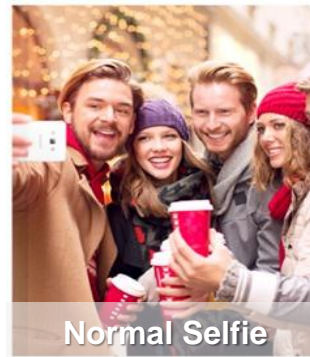

#### Palm gesture selfie

Take selfie automatically with palm gesture

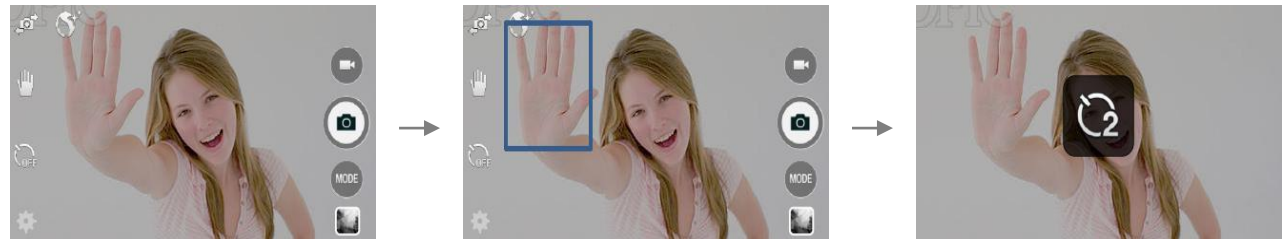

Entering Path : **CAMERA**

# Key Features

## Downloadable Themes

Home Screen, Lock Screen and preinstalled applications can be customized with downloadable themes.

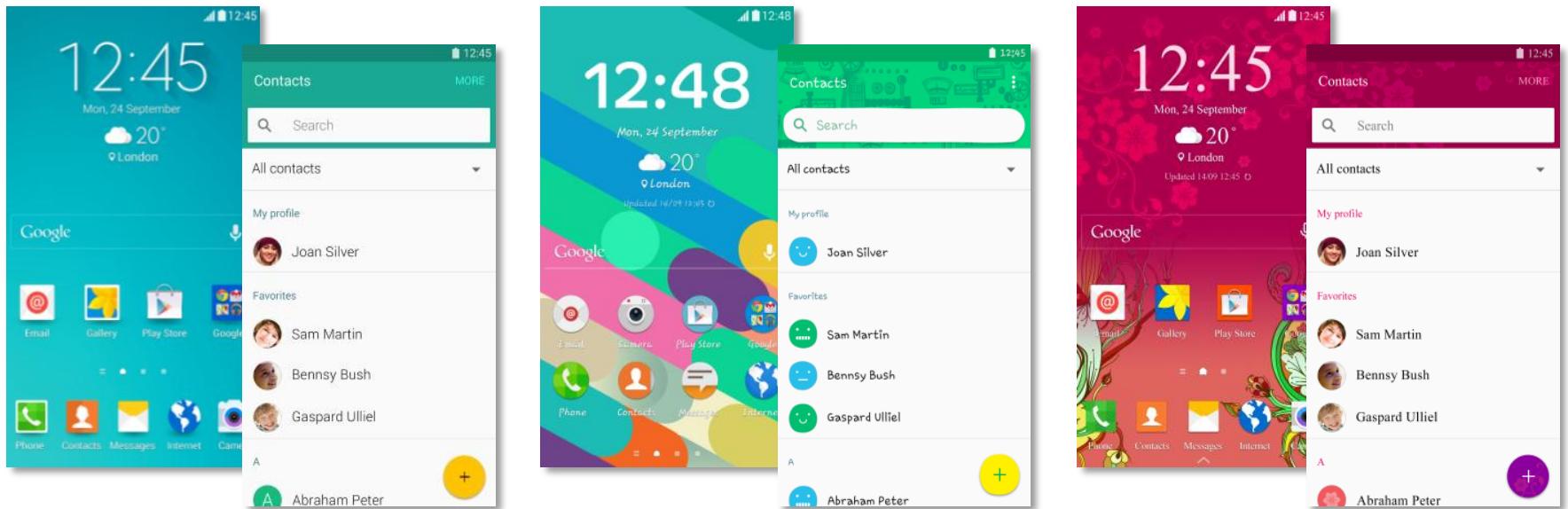

# Key Features

## Downloadable Themes

To change theme, long press empty space on the Home Screen and tap “Themes”. More themes can be downloaded from Theme Store.

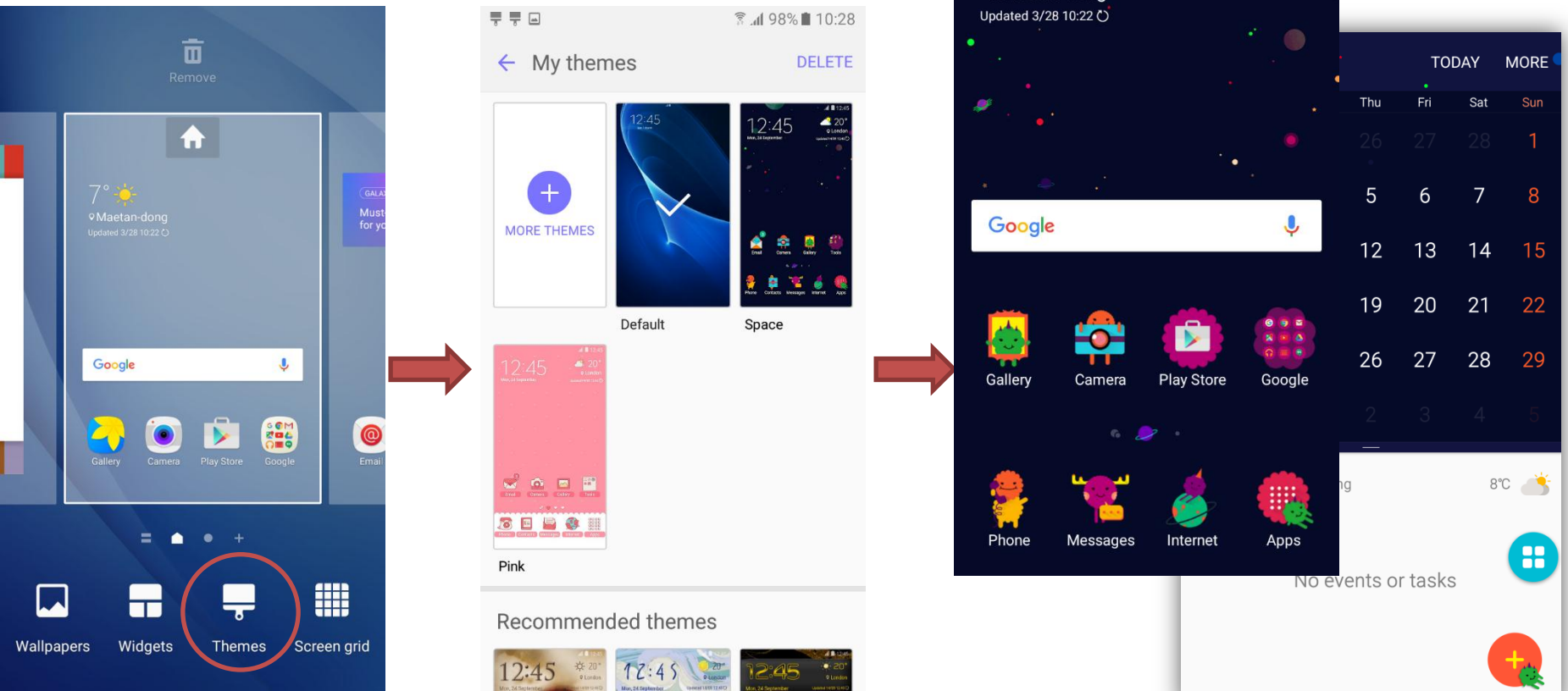

# Key Features

## Smart Switch

Smart Switch helps switching to a new phone by transferring data from old device.

Supports importing data from either Android or iOS devices.

After user set up Zero device for the first time, he receive notification suggesting to install Smart Switch to initiate data transfer

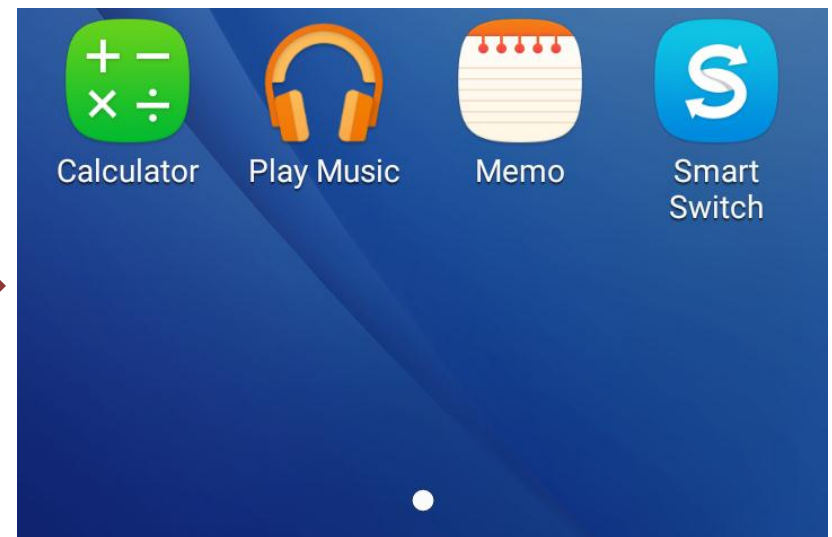
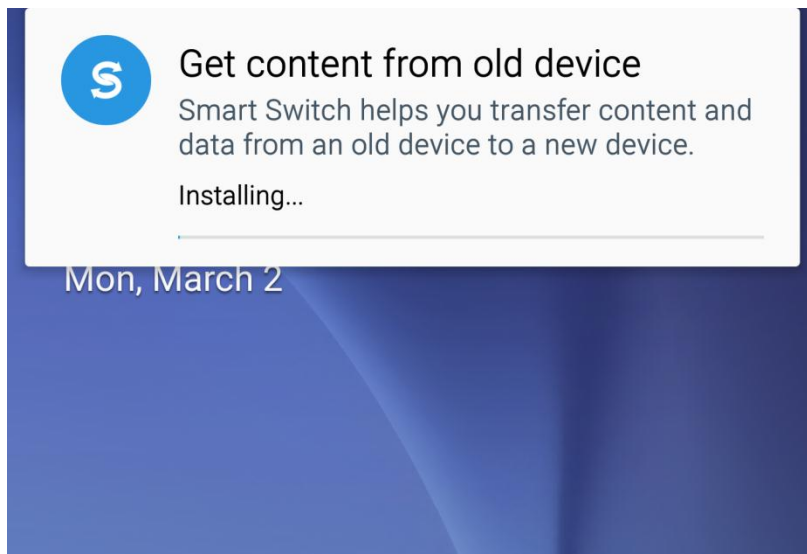

# Key Features

## Smart Switch

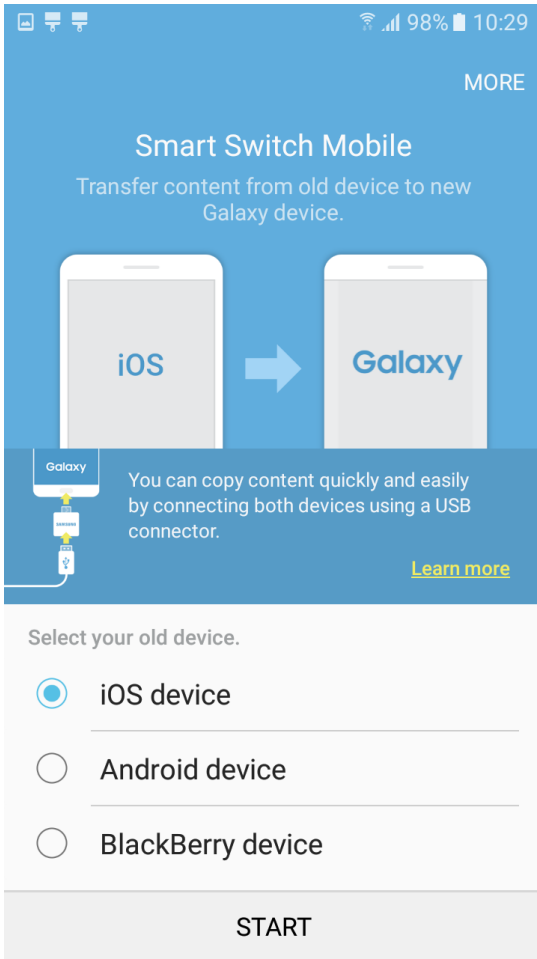

Smart Switch Mobile  
Transfer content from old device to new Galaxy device.

iOS → Galaxy

You can copy content quickly and easily by connecting both devices using a USB connector. [Learn more](#)

Select your old device.

- iOS device
- Android device
- BlackBerry device

START

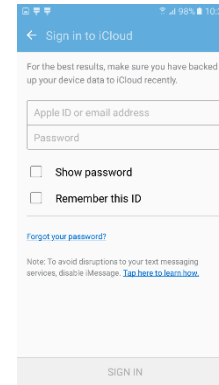
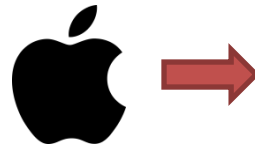

Sign in to iCloud

For the best results, make sure you have backed up your device data to iCloud recently.

Apple ID or email address  
Password

Show password  
 Remember this ID

[Forgot your password?](#)

Note: To avoid disruptions to your text messaging services, disable iMessage. [Tap here to learn how.](#)

SIGN IN

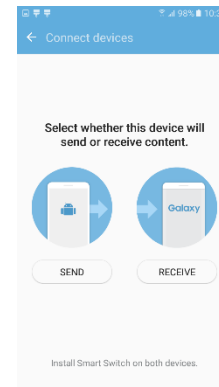
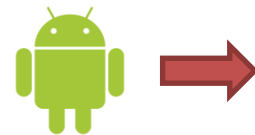

Connect devices

Select whether this device will send or receive content.

SEND  RECEIVE

Install Smart Switch on both devices.



Connect devices

BlackBerry → Galaxy

Connecting to BlackBerry devices

1. Install Smart Switch on the BlackBerry device, following the guide on the Smart Switch website. ([www.samsung.com/smartswitch](http://www.samsung.com/smartswitch))
2. Open the app on both devices.
3. Tap Connect on the BlackBerry device, select the network name, then enter the password shown below.

Network name:  
SS\_SM-J510FN\_1525

Password:  
.....

# Key Features

## Smart Switch



1. Install Smart Switch on sending device.
2. Press "SEND" on sending device and "RECEIVE" on receiving device.

The devices would pair through audio signal and initiate data transfer.

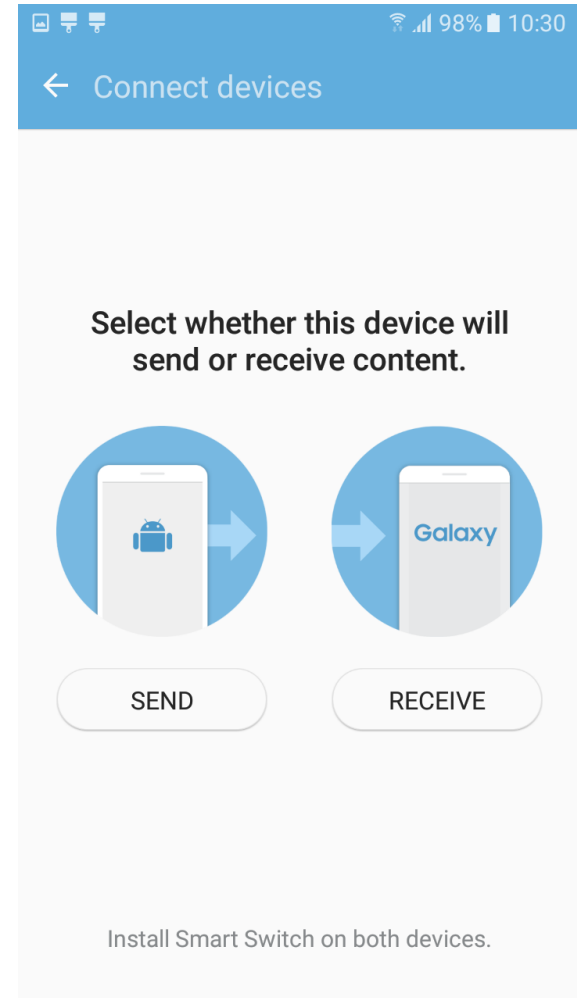



# SVC Technical Information

## Basic Information

AP Chipset	CP Chipset	IF Cable	RF Cable		RF Divider
Qualcomm MSM8916		GH81-10952A (7PIN)	GH81-11962G (pi : 1.35T)		-
Charger Spec			Charging Current Standard	New Pocket Type	Water Resistance
Adaptor (5.0 V-1.55A)			650~1550mA	-	-

## SVC Jig List for SM-J510

Item	Code	Item	Code
Mobile Dryer	GH81-11901B	ACRYL JIG REWORK FOAM	GH81-12065A
Hot Plate	GH81-12712E	OCTA Disass'y Jig Upper	GH81-12833A
OCTA Disass'y Holder	GH81-12119A	Double Sided Tape	GH81-12126A
Glass Absorber	GH81-11902A	Pressing JIG Body	GH81-11903A
TSP tape Attaching JIG	GH81-11905A	Pressing Pad(for OCTA)	<b>GH81-13537P</b>



Copyright © 2014 Samsung Electronics

This guide is protected under international copyright laws.

No part of this guide may be reproduced, distributed, translated, or transmitted in any form or by any means, electronic or mechanical, including photocopying, recording, or storing in any information storage and retrieval system, without the prior written permission of Samsung Electronics.